

Sept. 29th
1928

15 Cents
Per Copy

RADIO

REG. U.S. PAT. OFF.

WORLD

The First and Only National Radio Weekly
340th Consecutive Issue—Seventh Year

National Screen Grid 4

4-Tube A-C Set

HOW TO ARRANGE ECONOMY THREE

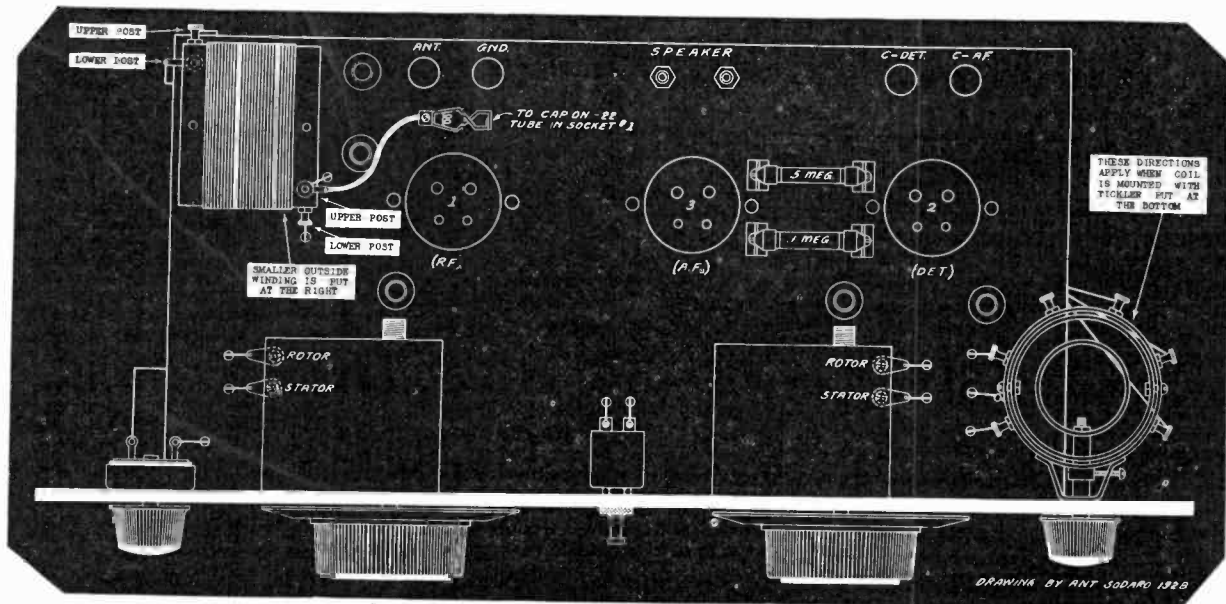

FIG. 1

TOP PLAN OF BERNARD'S ECONOMY THREE, SHOWING IN A NEW DIAGRAM HOW SIMPLE THE LAYOUT IS. NOTE THE DIRECTIONS WHICH APPLY TO THE SCREEN GRID ANTENNA COIL AND THE SPECIAL THREE-CIRCUIT TUNER. BOTH OF THESE INDUCTANCES PLAY AN IMPORTANT PART IN MAKING THE CIRCUIT AS REMARKABLY EFFICIENT AS IT HAS PROVED TO BE BY ACTUAL TEST IN ALL PARTS OF THE COUNTRY.

This drawing is one-third scale. See article on pages 6 and 7

**BIG DEBATE
STARTS ON
DYNAMIC
SPEAKERS!**

*Vacuum
Tube Used
as Accurate
Voltmeter*

**1929 MODEL
VICTOREEN
FOR AC
OPERATION**

REMLER



New Tone FOR OLD RADIOS

—with this Power Amplifier and B Supply Unit

Camera-like fidelity of reproduction—lowest notes clear and rich—music such as you thought your radio could never deliver!

Three improvements—a new transformer principle, better use of the big power tubes, and stable plate and grid voltage supply—enable this unit to vastly better the tone quality of your present radio.

Available in semi-completed form . . . requires but an hour or so to put into operation . . . full clear instructions . . . works from lighting circuit . . . coupon brings complete details.



REMLER Twin-Rotor CONDENSER

For knife-edge tuning, use this famous twin-rotor condenser.

Specified in circuits that demand extraordinary accuracy and efficiency.

Price, \$5.00

REMLER Drum DIAL

Rigid, heavy construction, smooth, no back-lash, illuminated. Drum fifteen inches in circumference. Removable calibration strips.

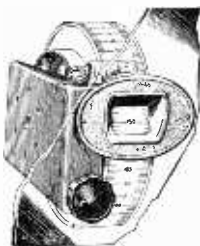

Price, \$4.50

Use the coupon below for full information on Remler Parts and Units.

Remler Division, Gray & Danielson Mfg. Co., 260 First Street, San Francisco, California.

Gentlemen: Please send me:

- All the "dope" on the "29."
- Bulletin service for professional set builders.

Name

Address

City State

Do you build and sell sets?.....RW-10

WOODEN HORN LOUD SPEAKERS GIVE BEST TONE!

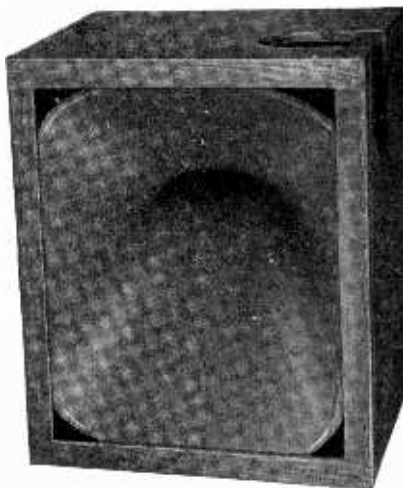

8-FOOT TONE TRAVEL!

Real MUSICAL Instruments are made of wood—Violin, Piano, Cello, etc. Wood is the Unsurpassed Vehicle of Sound. Wood ground to a pulp, pressed under thousands of pounds pressure, and moulded into an 8-foot long Tone Travel, gives you the very finest results! The Horn is wound around to Economize Space. All Notes come through Splendidly. Human Voice Incredibly Natural. In an Orchestra you can pick out each instrument. Unit (\$4.20 extra) fits in top, right.

Cat. No. 595; 21 1/4" high, 18" wide, 15" deep; mounted in baffle board **\$10.80**

Get No. 595—but if you can't spare the space, use Cat. No. 570 (6-foot tone travel; in baffle; 15" x 12" x 12") **\$7.80**

NEW HORN MOTOR!



Horn Motor, Cat. No. 112. Price \$4.20.

A splendid unit for horn loudspeakers. Stands 250 volts without need of filtered output. Enormous volume. Won't rattle. Excellent frequency response throughout audible range. Fits any standard nozzle, including our No. 595 and 570.

SEND NO MONEY!

ACOUSTICAL ENGINEERING ASSOCIATES, 143 West 45th Street, New York City.

- Please ship me at once the following (check off):
- One No. 595 at \$10.80, plus a little extra to defray shipping costs; send it already mounted in FREE baffle board.
 - One No. 570 at \$7.80, plus a little extra to defray shipping costs; send it already mounted in FREE baffle board.
 - One No. 112 horn motor (universal nozzle) at \$4.20 plus a few cents extra for shipping.

NAME.....

ADDRESS.....

CITY..... STATE.....

5-Day Guarantee of Money Right Back. Not only will we return your money, if you're not delighted, but we will then pay all packing charges and freight charges BOTH WAYS!

FEATURES TO FASCINATE and Inform You

Up-to-date Topics Masterfully Treated—See Which Ones You Must Become Fully Acquainted With to Round Out Your Radio Knowledge and Experience

The following issues of Radio World, 15c each:

OCT. 29—The Victoreen Power Supply with Audio Channel, by J. E. Anderson; Beauty of Sound and Appearance in Reproducers, by H. B. Herman.

NOV. 5—Part I of a two-part article on The Fenway Electric Concertrola; The Lynch Five, by Arthur H. Lynch; The How and Why of 3-Ft. Cone, by James H. Carroll.

NOV. 12—The New Nine-in-Line Receiver, by John Murray Barron; Part II on how to construct the Electric Concertrola; Unbiased Facts About Underbiased Grids, by Roger C. Brooks; Data on Meters, by Frank De Rose.

NOV. 19—Part I on how to build the Improved Laboratory Model Super-Heterodyne (Silver-Marshall Jewelers Time Signal Amplifier), by E. R. Pfaff; Part III of a four-part article on the Electric Concertrola; New Model DC Set, by James H. Carroll.

NOV. 26—The Four Tube DX Fountain, by Herbert E. Hayden; concluding installment on the Fenway Concertrola; A Squealless 5-Tuber, by Joseph Bernsley; Secrets of DX in a Creative Receiver, by J. E. Anderson.

DEC. 3—How to Modernize the Phonograph, by H. B. Herman; Part I of two-part article on the Everyman 4, by E. Bunting Moore; Efficiency Data on 4 and 5-Tube Diamond (not Screen Grid Diamond), by Campbell Hearn.

DEC. 10—Seven-page article on the Magnaformer 9-8, the best presentation in the history of radio literature, by J. E. Anderson (this article complete in one issue); The Object of a Power Amplifier, by C. T. Burke, engineer, General Radio Co.; Constructional Data on the Everyman 4 (Part II); The 2-Tube Phonograph Amplifier, by James K. Carroll.

DEC. 17—Complete Official Call Book and Log; How I Tuned In 98 Stations in Six Nights with Magnaformer 9-8, by Thomas F. Meagher; Starting Facts About Harmonics, by H. B. Herman; The G.R. Amplifier and B Supply, by Stuart S. Bruno.

DEC. 24—The AC 300 (four tubes); How Service Men Cheat Radio Builders; Part I of two-part article on the Victoreen Power Supply with one audio stage.

DEC. 31—How DC Sets Are Converted to AC Operation, by W. G. Masson-Burbridge; Cures for Uncanny Noises, by J. E. Anderson; Part II of two-part article on the Victoreen with a Stage of Audio; Complete Driver for an AC Set, by Robert Frank Goodwin.

JAN. 7, 1928—The Shielded Grid Six, first national presentation of loop and antenna models of the new Silver-Marshall circuit, utilizing the new tubes of strong amplification, Part I, by McMurdo Silver; How to Build a Power Amplifier and 210 Push-Pull Unit, by A. R. Wilson, of General Radio Co.

JAN. 14—Assembly and Wiring of Shielded Grid Six, Part II, by McMurdo Silver; Meter Range Extensions, by Bramhall Torrence; Uses of B Batteries and Power Devices, by E. E. Horine. National Carbon Co.; A 5-Tube Set Costing but 2 Cents an Hour to Run, by Capt. Peter V. O'Rourke.

JAN. 21—Bias Resistor Fallacy Exposed, by J. E. Anderson; The Shielded Grid Six, Part III (conclusion); How the "Victory Hour," Reaching 30,000,000, Was Broadcast, by Herman Bernard.

JAN. 28—How to Build the AC Five, a Battery-less Receiver, by H. H. Chisholm; Technique of Home Television Machine, by Dr. E. F. W. Alexander; A Quality Analysis of Resistance Coupling, with Trouble Shooting, by Herman Bernard.

FEB. 4—Tyrman "70" with Shielded Grid Tubes (Part I of four-part article), by Brunsten Brunn; The Four Tube Shielded Grid Diamond, by H. B. Herman; Television's Stride, by Neal Fitzalan, Radio Vision Editor.

Any copy, 15c. Any 7 copies, \$1.00. All these 15 copies for \$2.00, or start subscription with any issue. Any 8 of these numbers sent as premium with NEW yearly subscription. No other premiums allowed.

RADIO WORLD

145 West 45th Street New York City

POLO

DUO-MAGNETIC

UNIT

TWIN MAGNETS
DOUBLE SENSITIVITY

New!

The FIRST Twin Magnet Unit!

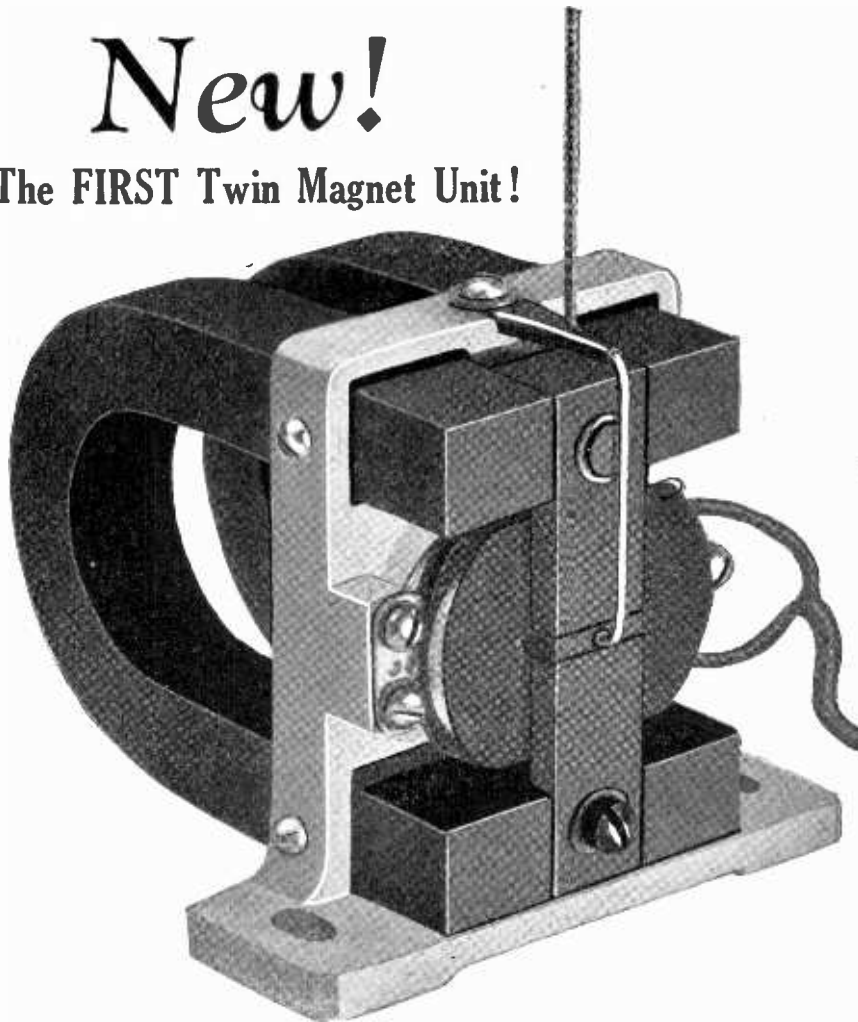

Polo Duo-Magnetic Unit, shown actual size. Weight three full pounds. Supplied complete with ten-foot cord, apex, chuck, nut and moulded metal mounting bracket (Senior model) \$10.00

No Filtering at 180 Volts!

THE magnet coil of the unit consists of two separate windings, connected in parallel, so that the current divides between them. This enables you to put **TWICE AS MUCH** current through the coil without danger of harming it! Use 180 volts on a -71A or -10 tube, with proper negative grid bias, and you do not need an output filter, the usual list price of which is around \$10.00. The coil of the unit safely carries 25 milliamperes!

Enormous Volume, No Rattling!

THE volume obtainable from a set depends to a large extent on the efficiency of the unit. The Polo Duo-Magnetic Unit is incredibly loud—enormously loud—yet without rattling! The **SENSITIVITY IS DOUBLED** by the use of two magnets—the first time two have been used in a commercial unit. The magnets are genuine, efficient, costly chrome steel, and there are no holes in them. Holes weaken a magnet and shorten its life.

ASTOUNDING

Performance—And Why!

THE new and startling Polo Duo-Magnetic Unit is of the balanced armature type, needing no adjustment and no servicing. It is exceptionally efficient, long-lived and mechanically rugged. Here is a summary of its superiority:

- (1) Twin magnets double sensitivity.
- (2) Magnets are of chrome steel.
- (3) Magnet coil consists of two windings in parallel, doubling the flux and the current handling capacity.
- (4) Volume is extraordinary, and without rattling, due to twin-magnets, great flux density, short air gaps, balanced silicon steel armature and single-piece coupling rod and pin. The pin **WON'T BREAK OFF!**
- (5) Die cast aluminum frame fits assembly to 1/1000 of an inch, enhancing rigidity.
- (6) Large, solid machined pole pieces.



Moulded bracket **FREE** with each unit order; also cord, apex, chuck and nut.

Every unit undergoes seventeen careful tests and is guaranteed against all mechanical or electrical imperfections. This unit needs no after-servicing, but will last indefinitely. It works superbly any cone, cloth, Balsa or skin speaker and is one of the most remarkable units ever produced. Make Polo your choice and you'll rejoice!

POLO ENGINEERING LABORATORIES,
57 Dey St. (Suite 6), corner Greenwich St.,
New York, N. Y.

Enclosed please find ten dollars for which send me one Polo Duo-Magnetic Unit, with ten-foot cord, moulded metal bracket, apex, chuck and nut. **YOU ARE TO PAY SHIPPING CHARGES.** If after a 10-day trial I return the unit **YOU WILL QUICKLY REFUND THE TEN DOLLARS.**

NAME

ADDRESS

CITYSTATE.....

IMMEDIATE DELIVERY

POLO ENGINEERING LABORATORIES

57 Dey Street

(Suite 6), Corner Greenwich Street
Tel. CORTland 5112

New York, N. Y.

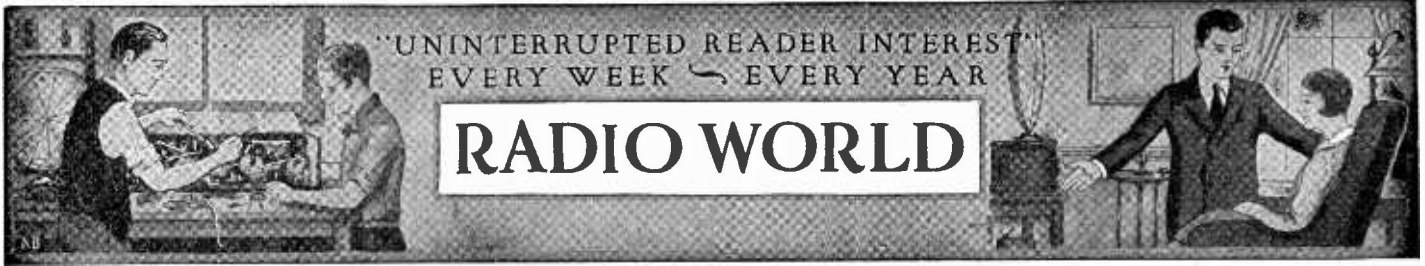

SEPTEMBER 29, 1928
 Vol. XIV, No. 2, Whole No. 340
 15c Per Copy, \$6 Per Year
 [Entered as second-class matter, March, 1922, at the post office at New York, N. Y., under Act of March, 1879.]

Technical Accuracy Second to None

A Weekly Paper published by Hennessy Radio Publications Corporation, from Publication Office, 145 West 45th Street, New York, N. Y. (Just East of Broadway) Phone: BRyant 0558 and 0559

The New National Screen Grid Four

CIRCUIT EXCELLENT FOR TABLE MODEL OR PHONOGRAPH CABINET

By Paul R. Fernald

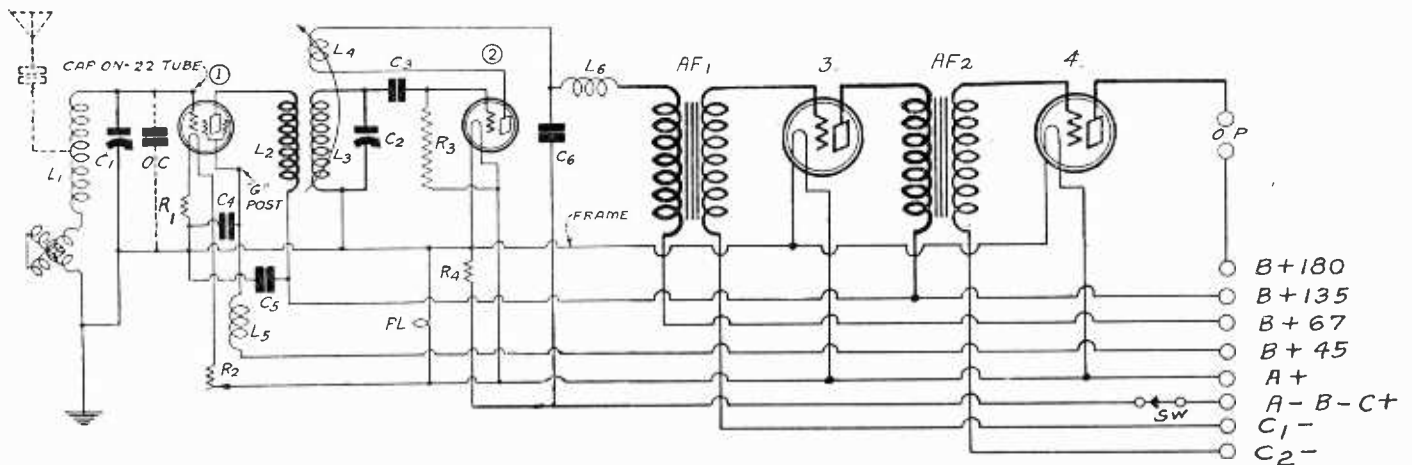

FIG. 1
 THE CIRCUIT DIAGRAM OF THE NATIONAL SCREEN GRID FOUR RECEIVER. THE FILAMENT SWITCH SW, THE RHEOSTAT R2 AND THE TICKLER L4 ARE ALL PUT ON THE SAME KNOB

THE National Screen Grid Four, presented herewith for the first time anywhere, possesses the cardinal virtues of any desirable receiver, namely, high sensitivity, adequate selectivity, operative simplicity and realistic tone quality.

Fans know these qualities now and they recognize their presence or absence in any receiver that bids for favor. Only those circuits which meet the test on these qualities survive, or even attain any popularity at all.

The National Screen Grid Five contains a type of impedance coupling which necessitated five tubes. If transformers capable of the same tone quality as impedance coupling are available the same results can be obtained with four tubes. Such transformers are now available and they have made the National Screen Grid Four possible, a compact receiver which has all the desirable qualities of the orig-

inal five with the added advantage that only four tubes are used.

Tuning Simplicity

That the National Screen Grid Four should possess the same high sensitivity, the same selectivity and the same operative simplicity is inevitable, for the same tuning unit and the same tube arrangement are used in the Four as in the Five. As a matter of fact, the new four-tube circuit is simpler to control than the five-tube circuit, for three of the controls have been combined in the same knob. Thus the filament switch Sw, the volume control rheostat R2 and the tickler L4 are all controlled by this knob.

The circuit was built for phono-graph cabinet installation, and is small enough to be accommodated in any such cabinet.

The value of the rheostat and the effectiveness of the tickler have been

co-ordinated so that the circuit is always operated at the optimum adjustment, that is, just under the oscillating point. It is possible to make the circuit oscillate only at high condenser settings, but the oscillation is as easily controlled there as if the tickler were operated by an independent knob.

Single dial tuning is made possible by the use of the inductive trimmer in the first tuned circuit. This trimmer consists of a small variometer in the relation to the first tuning coil L1, Fig. 1, which contains 14 turns of wire on a small form inside the main coil.

This coil may be turned through an angle of 180 degrees so that the inductance may be both decreased and increased from a mean value for which the first tuned circuit is matched with the second. Thus the detuning effect of almost any antenna can be compensated. This com-

pensating device not only serves to bring the two tuned circuits in synchronism but it serves as a fine vernier tuning control. This is particularly useful when a small antenna is used with the circuit and the circuit works excellently with a very small antenna.

The original five-tube circuit brought in distant stations on an indoor antenna only a few feet in length, and since the present circuit has the same sensitivity and the same effective audio frequency amplification, the short antenna may be used equally well.

Compactness Achieved

The extreme compactness is achieved by placing the audio frequency transformers under the National tuning unit chassis. Thus the length of the four-tube circuit is the same as the length of the chassis. The extreme compactness of the circuit is attested by the two photographs. Fig. 2 shows the interior of the set, which depicts the National tuning unit, the four tube sockets and the two auxiliary controls, that is the inductive trimmer and the rheostat-switch-tickler. The transformers cannot be seen, for they are placed under the sub-panel. Fig. 3 shows the front of the panel with the inductive trimmer knob at the extreme left and the rheostat knob at the extreme right. The single dial is in the center.

Assembly Simple

The assembly of the unit is made extremely simple by the use of the National tuning unit chassis, which is already wired up. The frame of this chassis runs the entire length of the set, so that many of the connections are made either directly or by means of leads not more than an inch in length. In fact there is so little wiring required that when the job is complete there is hardly any apparent.

The placement of all the binding posts in a strip back of the sockets also contributes to the neatness of the assembly because they are all placed near the points where the leads naturally terminate.

The two tuning coils in the National tuning unit are placed at the extreme ends of the chassis and they are at right angles in addition. Not only that but

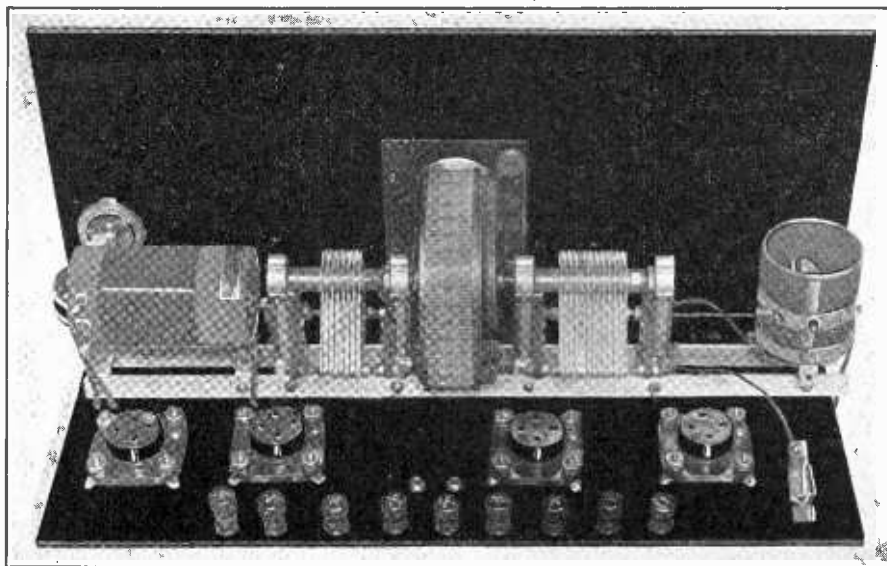

FIG. 2
THE INTERIOR VIEW OF THE NATIONAL SCREEN GRID FOUR RECEIVER SHOWING THE NATIONAL TUNING UNIT, THE SOCKETS AND THE BINDING POSTS STRIP

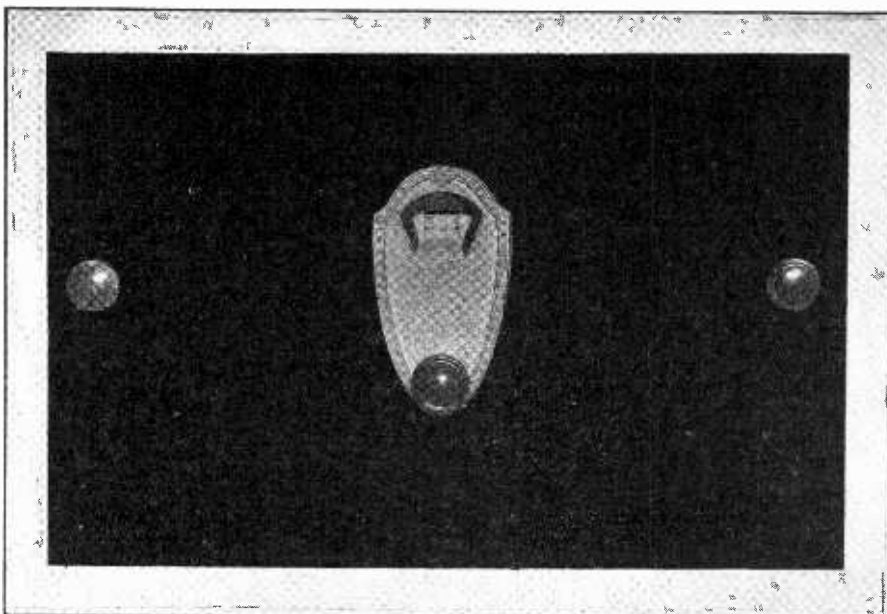

FIG. 3
THE PANEL VIEW OF THE NATIONAL SCREEN GRID FOUR RECEIVER SHOWING ONLY ONE DIAL AND TWO AUXILIARY CONTROL KNOBS

LIST OF PARTS

L1, L2L3L4, C1, C2, PL—One National single dial tuning unit BD No. 222 with No. 28 illuminator (unit consists of drum dial, antenna coupler and detector coils, two knobs and two tuning condensers, mounted on frame).

AF1, AF2—Two National audio frequency transformers, type A100.

C, 0C—Two Aerovox .0001 mfd. moulded mica condensers.

C3—One Aerovox .00025 mfd. moulded mica condenser.

C4, C5—Two Tobe 5 mfd. by-pass condensers.

C6—One Aerovox .001 mfd. moulded mica condenser.

1, 2, 3, 4—Four General Radio UX sockets.

R1—One Lynch 15 ohm Equalizer, with single mounting.

R2, Sw—One Carter 20 ohm rheostat with switch.

R3—One Lynch 2 megohm grid leak.

R4—One Lynch 4 ohm Equalizer, with single mounting.

L5, L6—Two National RF chokes, with two single Lynch mountings.

One Bakelite front panel.

One Bakelite subpanel.

One extra knob to match those on coil shafts, and to be affixed to the rheostat and switch shafts.

One No. 45 Universal Peewee Clip for cap of 222 tube.

Ten binding posts.

the drum dial, which constitutes a metal shield, are placed half-way between them. Hence there is no chance for any stray coupling between the two tuned circuits. Uncontrollable oscillation is impossible. The only way to secure oscillation is to turn the tickler to the proper position. Thus the circuit is completely under the control of the operator.

Any stray coupling which would result from common leads is eliminated by the use of by-pass condensers and radio frequency choke coils. Thus C4 and L5 prevent any variation in the voltage applied to the screen grid and hence any feed-back by that route, as this filter works both ways.

By-pass condenser C5 and choke coil L6 serve the same purpose in the plate circuit of the detector tube as C4 and L5 serve in the screen grid circuit. It passes audio currents and not radio currents and hence keep radio frequency currents from entering the plates voltage supply, whence they would find their way back to the first tube. To make the filtering of the radio frequency currents still more complete and to keep them in the proper place by-pass con-

denser C5 is connected across the plate supply leads for the first tube.

First Suit Begun Against Power Cut

Chicago
Clinton R. White, owner of WCRW, has filed the first suit to restrain the Federal Radio Commission from reducing the power of a broadcasting station. The Commission has ordered this station's power cut from 500 to 100 watts.

The suit is expected to be a test case challenging the Commissions' authority to order stations off the air in accordance with the Radio Act of 1927.

COMPLETE ADVANCE STATION LIST

Sept. 22 issue of RADIO WORLD contained complete advance list of stations compiled according to the new allocation plan of the Federal Trade Commission, effective Nov. 11. Mailed for 15c a copy, or send \$1.00 for trial subscription of 8 weeks, starting with Sept. 22 issue. RADIO WORLD, 145 W. 45th St., N. Y.

Five Switches and

THE STORY OF WHAT HAPPENS TO

By Herman

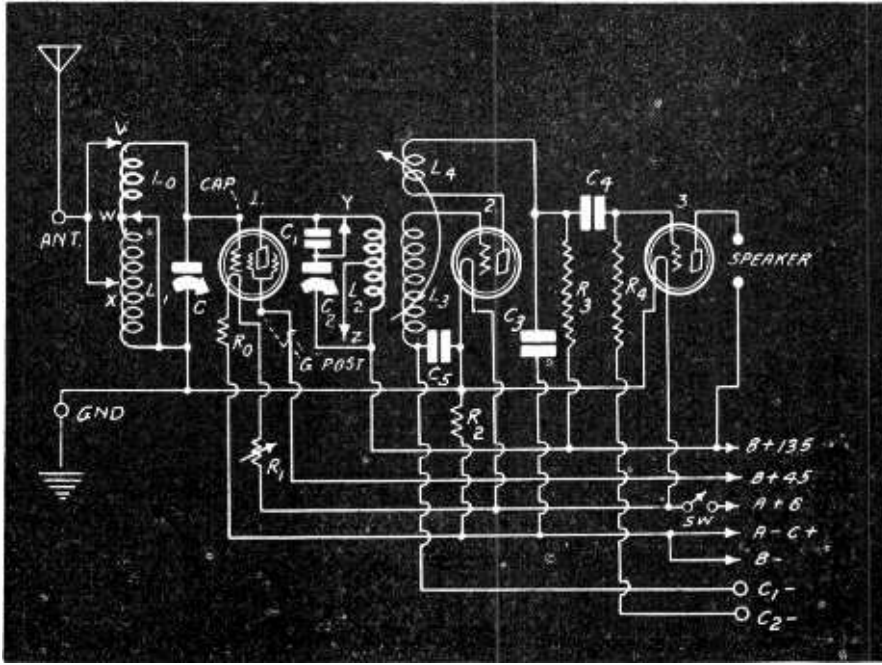

THE CIRCUIT DIAGRAM OF THE ECONOMY SCREEN GRID THREE. THE FIVE UNUSUAL SWITCHES ARE EXPLAINED IN THE TEXT

THE Economy Three, which works a speaker with only one stage of resistance coupled audio amplification, would be so easy to build you might try it with your eyes shut, were it not for the switches. The circuit was described in the September 15th issue of RADIO WORLD, and the functions of the switches were stated, without details. These details will be presented now.

At a glance, seeing a grand total of six switches, one might suspect that the designer had been unable to make up his mind. After a few months of patient experimenting it might be decided that the switches were properly included, each one of them, and perhaps a few words of thanks might be uttered, that the circuit not only performed so well at the start, but remained free from trouble.

The switches are minor points, the main ones being that only three tubes are used, yet the sensitivity is high, the selectivity good, and the tone quality very remarkable,—all for \$20.41.

Like Short-Wave Feature

It was assumed that the set-building public would like a broadcast receiver that would dip a bit into the short waves, and this supposition accounts for every blessed one of the five subpanel switches. The assumption was not amiss, because fan mail shows that the tremendous hold that this circuit has taken upon the country is due in at least a moderate degree to the inclusion of some short-wave tuning, without changing coils. Of course the outstanding reason for the circuit's popularity is that it does so much on the broadcast band for so little outlay.

Let us get the biography of each one of the five unusual switches, since biography is the literary craze of the day.

Switch V—This connects to the antenna binding post and enables bringing the antenna directly to grid of the radio fre-

quency amplifier tube, the desired position when tuning in short waves, of which tuning more details will appear presently.

Switch W—This enables shorting out nearly all of the tuned circuit, leaving only a few turns between its contact point and grid of the RF tube, so that for short waves an aperiodic input is used. These few turns are not tuned, but constitute a mere pickup, for amplification and tuning in the detector stage. Hence when short waves are sought, the tuning condenser C is set at minimum capacity, and not molested. Note that to constitute a part of the winding an aperiodic input, both switch V and switch W are closed, whereas when this is done, switch X must be open, otherwise there would be no input.

Switch X—This is the connection point for the antenna for broadcast wavelengths, and when it is closed for that use, both switches V and W must be open.

Switch Y—This shorts out a series condenser, so that the series condenser is not effective, when broadcast wavelengths are to be tuned in. Whether this series condenser is in or out makes no difference as to what minimum wavelength may be tuned in, but makes a considerable difference what maximum wavelength is receivable. The fixed condenser is .00025 mfd. As C2, its associated tuning condenser, is .0005 mfd., inclusion of the series condenser turns C2 effectively into a .00017 mfd. tuning condenser. As such it tunes a .0005 mfd. type coil up to about 350 meters, no more, so, if you want to tune in low broadcast wavelengths with maximum separation, and thus more easily get distance in this range, push in the switch knob (thus opening the switch and cutting in the series condenser). However, the series condenser is mainly reserved for tuning below the broadcast band.

Switch Z—This is connected from the midtap of the tuned primary in the plate circuit of the screen grid tube, to B plus

LIST OF PARTS

L0L1—One Screen Grid Antenna Coil. (Model 2A)

L2L3L4—One Screen Grid three-circuit coil, with step-up ratio and midtapped primary (Model 5HT).

C, C2—Two .0005 mfd. variable condensers.

C1, C5, C3—Three .00025 mfd. fixed condensers.

V, W, X, Y, Z, SW—Six switches.

R0—One 20-ohm fixed resistor.

C4—One .01 mfd. fixed condenser.

R1—One 10-ohm rheostat.

R2—One 2-ohm fixed resistor.

R3—One .1 meg. metallized resistor (Lynch.)

R4—One 5 meg. metallized fixed resistor (Lynch.)

1, 2, 3—Three sockets.

Speaker—Two tip jacks.

One 5-lead battery cable.

Four binding posts (Ant., Gnd., two C—).

One 7x18-inch front panel.

One 7x14-inch subpanel.

Two dials.

One knob for tickler to match rheostat knob.

Four subpanel clips for mounting R3 and R4.

One No. 45 Universal Peewee clip.

One screen grid tube, one 240 high mu tube and one 112A tube (All these Harmonique.)

Two subpanel brackets 1-inch high.

135, so that by pulling the switch closed, only half of the primary is used, while by pushing in the switch knob, breaking the circuit, the entire primary is tuned. Using only half of the primary alone accounts for ability to tune in stations below the broadcast waves (higher than broadcast frequencies). You can get down to about 126 meters that way. If you use a tap nearer the plate than center-tap you will get down lower—perhaps as low as 85 meters, but when you're that far down you have trouble controlling the tickler, and also find that for some wavelengths, contrarily enough, oscillation fails, due perhaps to the distributed capacity of the untuned secondary, plus that secondary's natural period being in the region in which you're trying to tune, and heavy absorption taking place. Hence it is just as well to rely on the center-tap only, and be content with 126 meters as the lowest wavelength.

All five special and unusual subpanel switches thus have been disposed of, and there now remains only the front panel battery switch, but as that needs no explanation, why give it one?

Unusual Ground

An unusual point to ground was selected—negative filament of the two five-volt tubes. This was done because it proved highly desirable to ground the rotor of the condenser tuning the screen grid tube. The grid return of this tube is made to the 5-volt position for right bias. The B plus 135 post is scarcely higher than ground potential, so body capacity effects are absent.

The series condenser C1 was put in the plate side for that same reason. If it were in it would leave the rotor at a considerably high radio frequency potential.

The wiring of the receiver is very simple,

What They Do

THOSE STRANGERS IN THE ECONOMY 3

Bernard

except, as has been intimated, the switches. The coils recommended for the circuit consist of an antenna coil having a continuous winding with two taps, hence four terminals, and a three-circuit coil of special design. The antenna coil permits of antenna connection to a point near the grounded end of the winding, or at a point much nearer the grid. The greater volume is obtained when the antenna binding post lead nearer to grid is used, for then the antenna circuit consists of most of the winding of the entire coil. For much greater selectivity, with less volume, use the other binding post. Hence the circuit may be permanently connected either way, as better suits a particular location. City dwellers will want the extra selectivity. Folk far from large centers will require the other connection.

Little Wiring In View

The switch wiring, and the antenna coil connections, are set forth very clearly in the blueprint, showing the underneath wiring. Fig. 1 (front cover) gives a top plan of the subpanel, and reveals all the wiring you actually see when you lift the cabinet lid. It is very little indeed, only the barest minimum, and that is the favorite method with home constructors and custom set builders to-day, since it makes for greatest neatness.

Underneath the subpanel point-to-point wiring is carried out, because it is more efficient, as well as easier to perform. None of this wiring is seen, after the receiver is housed, but every one who knows his radio will appreciate when seeing the blueprint that the wiring is well and simply laid out.

The blueprint is so fashioned that it depicts each wire and connection in exactly the direction taken in the wiring from your position when you are doing the wiring. That means that if you took the reality of

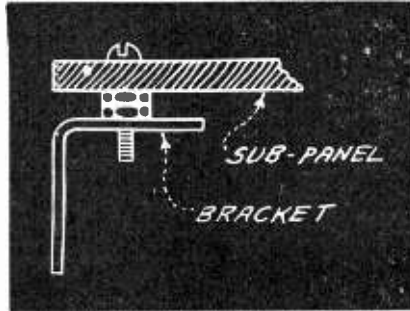

BRACKETS, IF USED, SHOULD BE ONE INCH HIGH, BUT AS THE SWITCHES WILL JUST GRAZE THE BOTTOM OF THE CABINET UNDER SUCH CONDITIONS, ELEVATE THE SUBPANEL BY THE METHOD SHOWN IN THIS DETAIL. DO NOT USE TWO-INCH HIGH BRACKETS BECAUSE THEN THE CABINET LID WOULD STRIKE THE CAP OF THE SCREEN GRID TUBE.

Fig. 1 and turned it upside down, in a backward direction, you would reverse the relative front-and-back positions of the parts, the front panel would be farther from you, instead of nearer to you than the binding posts, and the wiring that from a transparent top view would be from right to left, would really be from left to right.

Where This Point Excels

This reversal is not normally taken care of in blueprints, and the builder is put to the confusing task of reading the line from left to right and reversing it mentally so as to be sure to get it right physically.

One can't be sure always, and many a set has failed to perk, many a tube has been blown out, just because the blueprint failed to take into account that the underneath wiring is like a reflection in a mirror. The "print" should read backward.

The position of the parts on the top of the subpanel is shown in dotted lines on the blueprint's underneath wiring plan, so there is no possibility of going wrong, and you actually realize what you are doing each time you make a connection.

The blueprint therefore is the best guide to the construction of the receiver and the insurer against error in the connections of the otherwise confusing switches. But as any stumbling blocks of the schematic cease to be such in the blueprint, any one desirous of constructing this very remarkable receiver that actually does work a speaker beautifully, by all means should get the blueprint. Even if you do not intend to build the set you should see the blueprint, to understand just what is meant when the cry is made for reversal of direction to simplify following the print, for otherwise the blueprint does not show the wiring as it actually is on bottom, but as it would be if done on bottom while you were contortedly looking through a sub-panel from the top. As subpanels never are transparent, at least blueprints should be, and it will give any one real pleasure to see such a genuine blueprint as this.

COMPLETE ADVANCE STATION LIST

Sept. 22 issue of RADIO WORLD contained complete advance list of stations compiled according to the new allocation plan of the Federal Trade Commission, effective Nov. 11. Mailed for 15c a copy, or send \$1.00 for trial subscription of 8 weeks, starting with Sept. 22 issue. RADIO WORLD, 145 W. 45th St., N. Y.

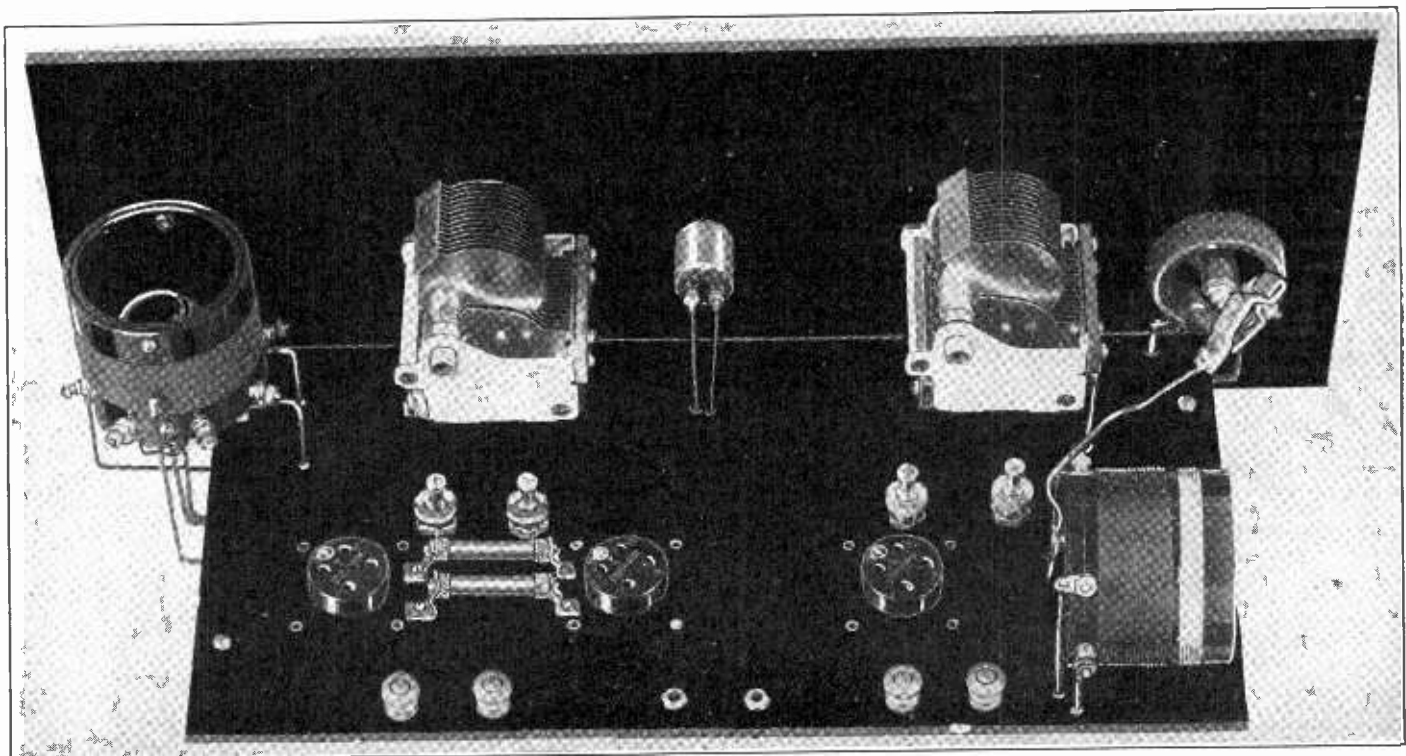

REAR VIEW OF THE ECONOMY THREE

What About Dynamics?

By Charles P. Madsen

Director of Research, Stevens Manufacturing Corp.

IT IS freely claimed that the efficiency of the usual rocker type driving unit for cone speakers is from 4 to 7 per cent, and that its power rating is strictly limited to that for which it is set. The Western Electric unit, for example, is set for 1 watt, the BBL for 2.5 watts, while the Stevens unit will take 3 watts and still maintain an efficiency of 7 per cent, although at 0.5 watt its efficiency is only 2 per cent.

Theoretically, the electrical efficiency of the dynamic closely approximates 100 per cent, and it can be designed to handle much higher power with less drop in efficiency at low power. Furthermore, it permits of a long stroke without mechanical transformation. This indicates the use of a small cone which enables the speaker to be made up in the small sizes now so popular. Again, the long stroke possible at least theoretically enables the dynamic type to render the bass notes more satisfactorily than an electromagnetic unit.

But the question is simply this: Do we get these characteristics in the commercial dynamics now on the market? And the answer is: Most emphatically not! What, then, do we get, and what is the cost?

Attributed to Lodge

The dynamic unit originated in the current balance developed by Sir Oliver Lodge several decades ago. This was considered a nearly absolute measurement of direct current at very low voltage. A triode or three-element vacuum tube, however, delivers alternating current at high voltage. Therefore, we must contend with such factors as high ratio transformation, impedance matching, mutual inductance, reactance, and distributed capacity.

Accordingly, to obtain with alternating current of high voltage an efficiency which even remotely approximates that possible with low voltage direct current, we must enlist the aid of designing skill of the highest order.

Even then, it is quite impossible to meet some of the theoretically necessary conditions.

As a matter of fact, the very best design available develops an electrical efficiency of only 50 per cent, and this figure is attained only by employing a push-pull transformer which has been specially designed and constructed of very expensive material.

Where Efficiency Is Greater

The electrical efficiency of some of the most popular makes of electro-dynamics is a scant 30 per cent when actuated by push-pull amplifiers. When, however, they are actuated by ordinary transformers and from a single power tube, the efficiency drops to as low as 20 per cent with some distortion. In some of the cheaper makes, the efficiency is further impaired by mechanical losses due to the cone suspension.

These figures, let it be understood, are electrical only, and to obtain the overall efficiency, we must subtract the cone losses.

It is quite true that in cones of the same size—the 18-inch size, for instance—the efficiency of a cone actuated by a dynamic unit is greater than that of one actuated by an electromagnetic unit.

This is due to the greater power available for flexing the material, provided, of

[This article by Charles P. Madsen, disparaging nearly all dynamic speakers, will undoubtedly evoke a great deal of heated discussion, since many engineers of equally high standing regard the electrodynamic speaker superior to the electromagnetic.]

Mr. Madsen is a research engineer who is well known in chemical, electrical and phonograph fields for his numerous inventions. His views are presented because his standing entitles him to a full expression of them. Opposing viewpoints will be presented as they are received. In neither instance are the view points to be taken as those of Radio World.—Editor.]

course, that the source is capable of furnishing the energy. On the other hand, it is well known that the amplitude of the apex of the cone varies inversely as the square of its diameter, plus a logarithmic constant for air slippage.

In practice, this works out so that if an 18-inch cone requires .008 inch amplitude down to 100 cycles, then a 7-inch cone will require .062 inch down to the same frequency. If, however, a dynamic speaker could reach only 100 cycles, it would not be satisfactory; and to reach 48 cycles, a stroke of plus or minus $\frac{1}{4}$ inch or $\frac{1}{2}$ inch is necessary.

It is, of course, theoretically possible to make a dynamic unit with this stroke, but at present there are only two commercial speakers of this character, and both are sold complete with amplifier and power plant.

The very best dynamic unit for 7-inch cones has a possible stroke of plus or minus $\frac{3}{32}$ -inch. Others have a possible stroke of $\frac{1}{16}$ -inch. One type examined in our laboratory had as little as $\frac{1}{32}$ -inch stroke. It therefore must be obvious that the dynamic loudspeaker with such limited stroke has no greater efficiency than an 18-inch cone equipped with a good electromagnetic unit. As a matter of fact, exhaustive laboratory tests show it to have less, the reason being that its mechanical losses are greater.

Other Sources

The mechanical losses, extreme in the case of the $\frac{1}{32}$ -inch stroke, yet present in all dynamic units, are due to the fact that we do not yet know how to suspend the cone and coil centrally, so that the mechanical resistance will not increase as the stroke increases.

Perhaps the reader will be better able to realize why the cone efficiency goes down so rapidly if he stops to consider that it is far easier to swing a baseball bat with the full grip of both hands than with the thumb and forefinger only.

Electrical troubles are caused by the following factors:

To begin with, dynamic units are not provided with a spring resilience as are the electromagnetic units. Push-pull actuation is therefore more essential. Again, in all cases an output transformer of special design is required, and unless made of special alloy cores which are quite costly, it can introduce quite as much distortion as a third stage of audio amplification.

Many makes of dynamic speakers now on the market are provided with cheap transformers, so that the distortion caused by combinations of capacities, chokes and resistances—including cut-off filters in-

tended to cover up poor design—tends to cut down the efficiency.

The greatest electrical loss, however, occurs in the movable coil itself. The impedance of the movable coil is not matched with the secondary of the output transformer; and even when it is nearly so matched, the I²R (power) loss of the coil is enormous.

The reader can obtain a really practical picture of this loss if he stops to consider that in a correctly designed step-down transformer whose ratio is 50 to 1, the secondary wire is No. 18 while the dynamic coil is wound with No. 30 or 32! This means that the dynamic coil is being overloaded from 300 to 400 per cent.

The electrical efficiencies discussed above are those of the signal system only.

In addition, we must consider the efficiency of the field, which is from 10 to 25 per cent. When a field for the signal of a 112 type tube was required, this was quite immaterial. To obtain a field for the signal from the 210 or 250 type tubes in push-pull, however, requires enormous power.

Need Development

Dynamics of the kind having a signal efficiency of about 20 per cent with the field rated at $\frac{1}{2}$ ampere at 6 volts were found to take .7 watts at 6 volts, while those having a signal efficiency of 30 per cent required 16 watts.

Those with a signal efficiency of 50 per cent demanded a 50-watt field.

The latter field requirements are far above the usual output of eliminators.

Hence the field cannot be used as the eliminator filter choke, but must be fed with a separate rectifier.

It is therefore quite clear that dynamic speakers are in need of much development. In fact, the man who buys a separate dynamic unit today has just about as complete a dynamic speaker as the man who buys a Wright Whirlwind Motor has a complete transatlantic airplane.

The amount of engineering to complete the job is about equal in both cases.

In conclusion, it should be noted that the deep bass notes developed by many dynamics are additive resonance, and if one likes this effect one can readily attain it by much cheaper and simpler means. The deep resonance is caused by the fact that most dynamic cones are fastened to a metallic frame which, in turn, is bolted to a large wooden baffle acting in the capacity of a diaphragm. This serves to accentuate certain low frequencies.

To prove this, let the reader actuate a dynamic unit thus mounted, with an organ record of low pitch, and he will clearly hear a bass drum accompaniment. If this effect is desired, the same results can be produced with an impregnated cloth (of curved angle) glued to the same kind of baffle and actuated by a high-powered electromagnetic unit.

Chicago Transformer Corporation Starts

The new manufacturing plant of the Chicago Transformer Corporation, at 4541 Ravenswood Avenue, Chicago, is now in production. W. J. Leidy is president; Earl Knight, vice president; Arni Helgason, secretary, and G. R. Blackburn, treasurer.

New Push-Pull Circuit

By J. E. Anderson

Technical Editor

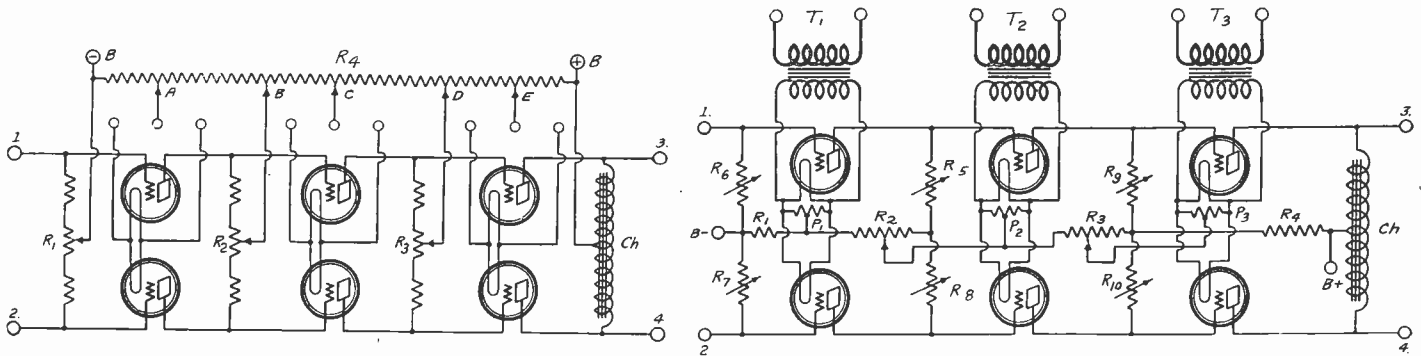

TWO OF THE PUSH-PULL RESISTANCE COUPLED AMPLIFIERS DISCUSSED. FIG. 1 AT LEFT AND FIG. 2 AT RIGHT.

[This is the third instalment of the exposition of a novel push-pull resistance coupled amplifier without stopping condensers between the stages. The first instalment was published in the September 15th issue and the second in the September 22nd issue of RADIO WORLD. Additional information will be published in future issues.]

THE drop in R5 should be 3 volts. It may be assumed the current is 50 milliamperes. Hence R5 should be 60 ohms. The drop in R6 should be 22 volts. The current here may be assumed to be 48 milliamperes. Hence R6 should be 458 ohms. R7 should have a total resistance of 4,100 ohms, 2,300 ohms on the left of the tap and 1,800 ohms on the right. The drop in R10 should be 157 volts and the value of the resistance should be 15,700 ohms.

Condensers C1 and C2 should be 2 mfd. units. Other condensers may be connected as explained for the three-stage circuit.

Complete Receiver

Fig. 4 shows a complete receiver in which a two-stage push-pull amplifier similar to that in Fig. 3 is used for audio amplification. The difference lies mainly in the fact that direct current is used on the filaments of the high mu tubes in the first stage. The curves used in designing this are shown in Fig. 6. Assuming that R8 and R9 have a value of .25 megohm each and the drop in R7 is 175 volts, the upper curve in the left graph is used.

This curve indicates that a bias of 2.75 volts is suitable. But as this is not easily obtainable in this particular circuit a bias of 2.5 volts may be used. This is partly obtained from the one volt drop R6 and partly from a single dry cell inserted at the point marked X.

When the bias is 2.5 volts the drop in either of the output resistors is 74 volts, 29 volts more than the 45 volts that should be used on the power tubes. Hence the mid-point on R10 should be connected

29 volts away from the junction of R8 and R9 on resistor R7. R11 should be connected to the junction and not to R10.

In the left portion of R7 the drop is therefore 146 volts and the current is 50 milliamperes. Hence that portion should be 2,920 ohms. In the right hand portion the current is about 10 milliamperes and the drop 29 volts. Hence the resistance should be 2,900 ohms. In other words, the tap should be near the middle of the resistor. A 5,820 ohm resistor is not available but it may be obtained by using a resistor with two sliders on it.

The drop in R11 should be 151 volts. With 10 milliamperes flowing in it the resistance must be 15,100 ohms.

The receiver shown in Fig. 4 has been worked with satisfactory results. This circuit did not hum.

The radio frequency amplifier and the detector used in this circuit are standard and have been described. In fact the amplifier may be connected to any detector by means of a transformer T1.

Transformer coupling between the detector and a push-pull amplifier seems to be the only practical solution. But some devotees of resistance coupling will not make a single concession to transformer coupling. There are possible means, but it cannot be said that they are thoroughly practical.

Grid Voltage Unsymmetrical

One simple scheme that presents itself is to use a crystal detector and arrange the circuit as shown in Fig. 7. The coil L1 is connected in the plate circuit of the radio frequency amplifier. The secondary L2 may be tuned or L1L2 may be a fixed radio frequency transformer designed to work efficiently in the broadcast band. R1 and R2 are the first coupling resistors in the direct coupled push-pull circuit. Both should be adjusted to the same value. Terminals 1 and 3 go to the grids in the first stage of the amplifier and terminal 2 goes to B minus. This terminal may be grounded.

No other point of the secondary circuit must be grounded. If it is, the push-pull amplifier will be active only on one side.

When this scheme is used adequate radio frequency amplification must be provided ahead of the crystal detector and all the selectivity required must be obtained in the radio frequency stages. A condenser of about .0005 mfd. should be connected across terminals 1 and 3 to aid in the detection.

There is one difficulty apparent in this arrangement. The rectifier admits current in only one direction. That is the principle upon which it works. This current will make one terminal, say 1, more negative and the other more positive by the same amount. Hence the bias on the grids of the first stage in the push-pull stage will not be the same.

This unbalance will be very small, but it will be amplified because the circuit following is essentially a direct current amplifier. That is, the unbalance in the second and third stages will be greater than in the first stage by the amount of amplification. It is possible to equalize this effect by inserting a small negative bias in series with one of the grid leads. If the current flows through R1, R2 in the direction 1 to 3, this bias should be put in series with lead 1 with the negative pointing toward the grid.

This unbalance cannot be removed by adjusting the resistance values of R1 and R2, and even if it were possible it would not be permissible, for the signal would be unbalanced if the resistors were unequal.

A possible method of coupling a tube detector to the push-pull circuit is shown in Fig. 8. This tube circuit must be entirely separated from the push-pull circuit as far as conduction is concerned, except at the points 1, 2 and 3. It must not be grounded except at point 2.

A separate plate battery B must be used, which follows from the condition that the detector circuit must be conductively isolated from the push-pull circuit except at the three points indicated.

The only advantages this circuit has over the crystal arrangement are greater selectivity and sensitivity. The grid bias unbalance is greater. In the crystal circuit the audio frequency unbalance due to distributed capacity is small. In this circuit this unbalance is much greater.

It is possible to correct the bias unbalance by means of a battery as it was done for the crystal detector. The audio unbalance, which is only appreciable at the higher audio frequencies, might be corrected by connecting condensers as required. But just what values, and where to place them would be a matter of experiment.

A heater type tube is shown in this detector because that is the only transformer-heated tube which can be used satisfactorily for detection. If a transformer is not used a separate A battery must be used because of the isolation condition.

(Continued next week)

LIST OF PARTS

(Fig. 1)

- R1, R2, R3—Three Carter 100,000 ohm potentiometers and six Amsco .25 megohm Grid gates with clips.
- R4—Carter voltage control kit.
- Ch—One National push-pull output transformer (only primary used).
- Six sockets.
- Four binding posts.
- Two—26 type tubes.
- Two—40 type tubes.
- Two—71A type tubes.
- Acme Parvult Condensers

LIST OF PARTS

(Fig. 2)

- R1, R2, R3, R4—Same as R4 in Fig. 1.
- P1, P2, P3—Three Carter mid-tapped 30-ohm resistors.
- R6R7, R5R8, R9R10—Three Duplex Clarostats.
- Ch—One National push-pull output transformer (primary only used).
- T1, T2, T3—Three suitable transformer windings.
- Sockets and tubes same as in Fig. 1.

AVacuum-T

ACCURATELY MEASURES

By Capt. Peter

IN many circuit tests a vacuum tube voltmeter is indispensable. For example, if it is required to adjust the grid bias very accurately it will not do to measure the voltage of the battery with an ordinary voltmeter and assume that the grid bias is that indicated by the meter. The result is never correct and it may be considerably in error if the battery used is old and run-down. The voltages on the various taps of a B battery eliminator cannot be measured accurately with an ordinary voltmeter. The actual voltage is always greater than that indicated, unless a high resistance meter is used.

If there is a resistance in the grid circuit and it is desired to measure the actual grid voltage it can be done only with a vacuum tube voltmeter. If the actual voltage at the plate of a resistance-coupled amplifier is desired it can be found only by the same type of meter.

Whenever the voltage drop in any resistance is required a true value can be found only by a meter which does not alter the current distribution when it is connected, that is, by a meter which itself does not take any current. A vacuum tube voltmeter is such a meter. It takes no current and no power to operate. It is a true potential meter.

Simple in Construction and Use

A vacuum tube voltmeter is very simple both in use and operation. It consists of an ordinary vacuum tube with a milliammeter in its plate circuit and provided with a suitable plate voltage. The circuit is shown in the accompanying drawing.

Where large values of voltage are to be measured it is best to use a tube having a low amplification factor, such as a -71A or a -50 type. The filament may be AC or DC heated according to which is the more convenient source. The drawing shows AC heating.

The plate milliammeter preferably should be one of low range, such as a O-1 or a still more sensitive meter. There are two reasons for the need of a sensitive meter. When the meter is very sensitive a high resistance must be used in series and this makes the output characteristic very nearly a straight line throughout the range. This is a convenience, though not a necessity. The other is that the small current required by the indicator tends to keep the voltage in the plate circuit constant, which is necessary to keep the calibration constant.

Also it is desirable to use a lower filament current on the tube than is used when the tube is operated as an amplifier. Constancy of calibration is gained thereby. But this is not necessary if a ready means of calibration is available, which should be a part of the meter.

High Mu for Low Voltage

If the voltages to be measured are relatively low a high mu tube may be used. Small voltages may be measured more accurately with such a tube. But for general work the low mu tube should be used.

Also, if the voltages to be measured are high, the plate voltage applied to the tube should be high. A greater direct range is gained thereby. But the range of any meter can be extended by a very simple contrivance which will be explained.

The voltage in the plate circuit of the tube may be derived either from a battery

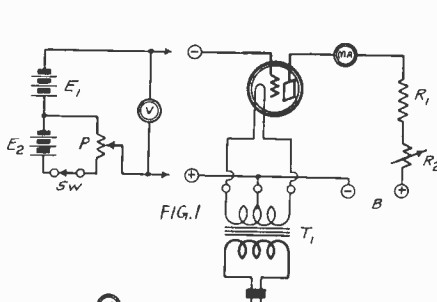

FIG. 1

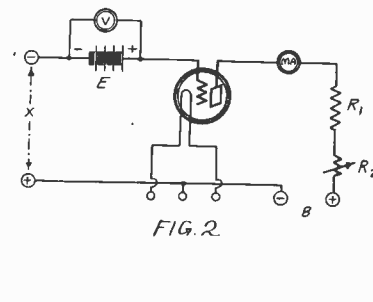

FIG. 2

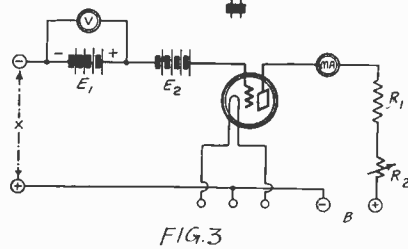

FIG. 3

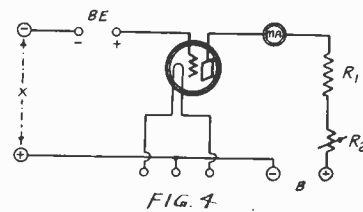

FIG. 4

FIG. 1—THE CIRCUIT DIAGRAM OF A VACUUM TUBE VOLTMETER WITH INDICATED ARRANGEMENT FOR CALIBRATING IT.

FIG. 2—THIS SHOWS HOW THE RANGE OF THE VACUUM TUBE VOLTMETER MAY BE EXTENDED BY CONNECTING A BATTERY IN SERIES WITH THE GRID LEAD. THE VOLTMETER V MUST BE ACROSS THE BATTERY E WHILE A READING IS TAKEN.

FIG. 3—WHEN THE VOLTAGE OF THE RANGE-EXTENSION BATTERY IS GREATER THAN THE RANGE OF V, PART OF IT, AS E2, MUST BE MEASURED FIRST WITH THE VACUUM TUBE VOLTMETER AND THEN INSERTED IN THE GRID LEAD WITHOUT THE METER ACROSS IT.

FIG. 4—THE VOLTAGE OF A B BATTERY ELIMINATOR BE MAY ALSO BE USED FOR RANGE EXTENSION PROVIDED THAT ITS VOLTAGE IS MEASURED FIRST WITH THE VACUUM TUBE VOLTMETER.

or a battery eliminator. The battery is probably more dependable, for only temperature will change its voltage over short periods of time. The battery eliminator voltage may change suddenly due to changes in the load on the power supply system. For similar reasons an A battery is more dependable than a transformer. In either case the calibration of the meter should be checked just before using and adjusted, if necessary.

The transformer and B battery eliminator are more convenient.

The calibration of the meter is a simple procedure. The method used is indicated in the drawing. A battery E1, variable in steps of 1.5 volts, is connected with the negative terminal to the grid. In series with this battery is a low-voltage battery, about 3 volts, shunted by a potentiometer P of about 400 ohms. From the slider on the potentiometer to the negative of E1 is connected a voltmeter of suitable range, depending on what type of tube that is used and on the voltage in the plate circuit. For a low mu tube the range should be 0-100 or 0-150 ohms.

Protection of Meter

At first the resistance of R1 and R2 is made high so as to protect the milliammeter. Then the battery E1 and the setting on P are adjusted until the voltmeter reads zero. There will be a certain reading the milliammeter. Adjust R1 and R2 until the reading is the maximum that the meter will indicate. This is the maximum that will be obtained at any time and it is a check value. The setting of R2 should always be such

that the reading is the maximum. R2 should be small in comparison with R1 so that fine adjustment is possible.

Record the maximum reading against zero voltage in a table. Now change the setting of P and the value of E1 if required, until the voltmeter indicates some desired or convenient value, say 10 volts. Take another reading on the milliammeter. Wait a moment until the value is steady. Record this reading against the grid voltage selected in the table. Continue to change the grid voltage as indicated by V by suitable steps until the reading on the milliammeter is zero. Find this value as accurately as possible for it is one of the limiting and check values.

When a set of readings has been obtained from zero bias and maximum value to maximum bias to zero value plot a curve of the points with grid bias as abscissas and current as ordinates, or vice versa if that is more convenient. Draw the curve as accurately as possible. It will be a straight line very nearly except near maximum bias and zero reading. More readings should be taken as the current decreases to make the plotting easier where the curve bends.

Wait for Steady State

At every reading wait for the steady state, that is, until the needle on the milliammeter stops drifting. This applies to both the calibration and later use of the meter. The drifting is mostly due to heating or cooling of resistors in the circuit.

The voltmeter V must be connected at all times when a reading is taken. The necessity for this will be seen by observing the

Tube Voltmeter

BIAS AND B POTENTIAL

V. O'Rourke

current when the meter is disconnected. It will decrease.

As soon as the curve has been plotted the meter is ready for use. The entire work of calibration and plotting can be done in 10 minutes after a little practice. It is not necessary to draw the curve with ink, for it may have to be done over in a short time, just to make sure that nothing has changed or to ascertain how much of a change has occurred. A fine pencil line is as good as an ink line.

When using the meter connect the grid of the tube to the minus end of the resistor across which the voltage is to be measured and the filament to the positive. Note the plate current when so connected. Look on the curve to find out what grid bias that current reading represents. That is the voltage sought.

It may be that the reading is zero. That indicates that the voltage to be measured is higher than the range of the meter. Hence the range must be extended. This is done by connecting a battery in series with the grid with the positive terminal to the grid. Then the unknown voltage is connected from the negative terminal of the battery to the filament. If the battery inserted has the proper value a current will now be obtained on the milliammeter. This corresponds to some voltage, which is the difference between the unknown and the voltage of the battery in series with the grid. Just add the voltage obtained from the reading on the curve to that of the battery and the value of the unknown voltage is obtained.

The voltmeter must be across the battery while the reading is taken or the result may be in error by several volts.

If the voltage of the battery in series with the grid is greater than the range of the meter V , the voltage of the battery itself must be measured with the vacuum tube voltmeter before it is connected in the circuit, in steps if necessary. When that has been done the voltmeter should not be across the battery while a reading is taken.

There is no limit to the range of the vacuum tube voltmeter if this method of extension is used, except the number of batteries or battery eliminators available for connecting in series with the grid.

The accuracy of the measurements is the accuracy of the voltmeter V , which should be at least 1 percent. That is very good in

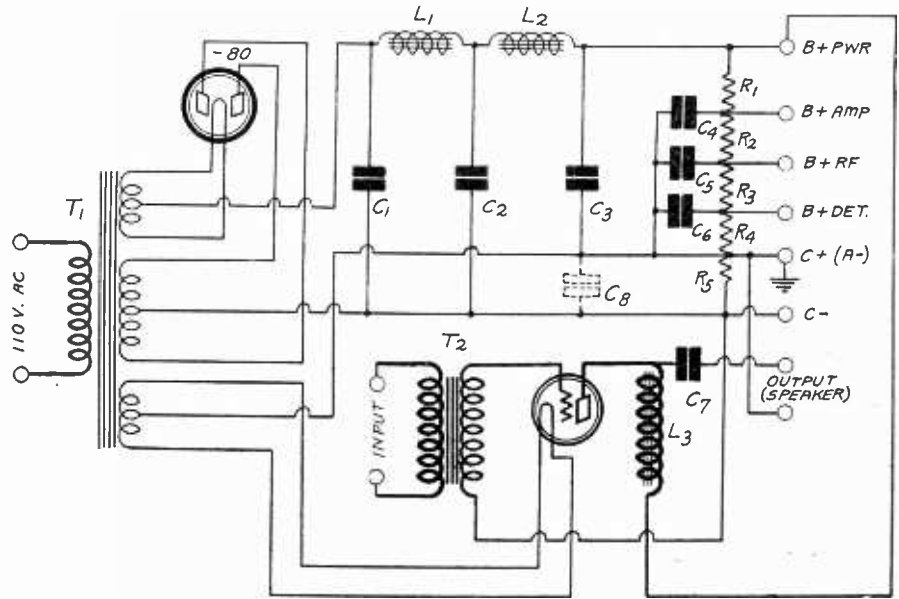

FIG. 5

THE VOLTAGES IN THE OUTPUT OF THIS POWER SUPPLY MAY BE MEASURED ACCURATELY WITH A VACUUM TUBE VOLTMETER. CONNECT C PLUS (A-) TO GRID OF VOLTMETER AND THE OTHER POINT TO PLUS ON METER. EXTEND RANGE IF NECESSARY.

view of the fact that the vacuum tube voltmeter is the only means of measuring certain potentials in a radio receiver, except an elaborate potentiometer used in physical laboratories.

New Airfonic Speaker Is of the Roll Type

A new speaker is the new Airfonic, for which Perry Saftler, Acme representative, is sole Eastern representative. This speaker is a development of Chester W. Hicks, engineer of the Admission Committee of Aeronautics, Langley Field, Va.

It is of the roll type, with the diaphragm made of specially treated paper, water-proofed and atmosphere-proofed.

The driving unit is of the newest magnetic

type with advance improvements, and will stand high voltage without filtration.

The Airfonic comes in two models, one about 16x27 inches, the other 18x48. Either can be had unfinished, the frame being mahogany and the diaphragm old blue leatherette, while the finished models are done in gold and black, the effect being that of a highly artistic Japanese lacquered screen, ornamental in any surroundings. The speakers are shipped unassembled and can be put together in a few minutes. A screwdriver is all that is necessary. The speaker driven by the Acme 250 power pack, is on demonstration at the Jay Eff-Eff Radio Service Co., 135 Liberty Street, New York City. Full information will be furnished at once to jobbers, dealers and fans who write to Perry Saftler, 122 Greenwich Street, New York City. MENTION RADIO WORLD.—J. H. C.

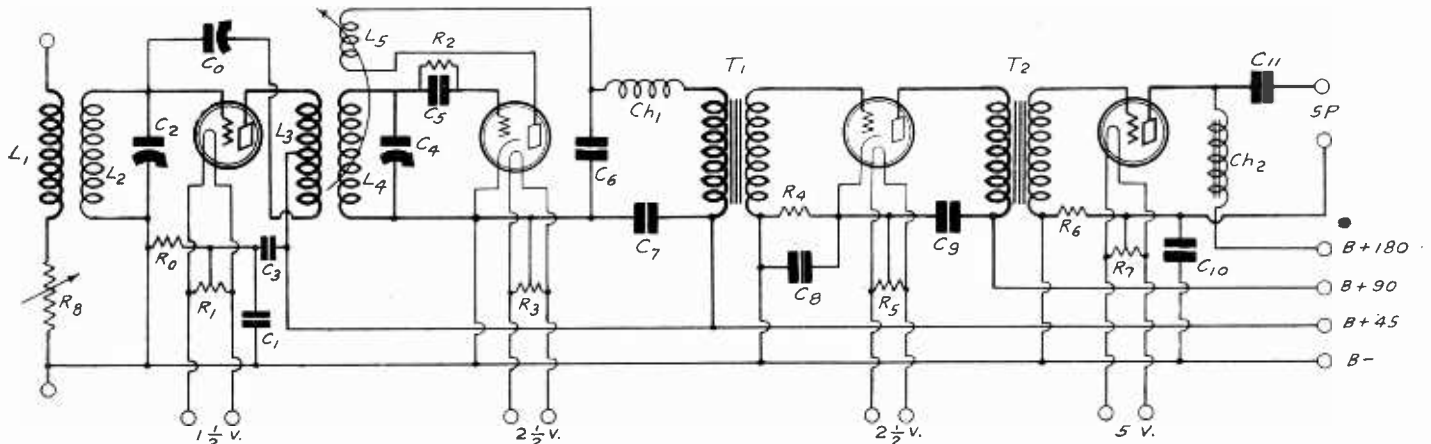

FIG. 6

THE BIAS ON THE GRIDS IN THIS CIRCUIT MAY BE MEASURED ACCURATELY WITH THE VACUUM TUBE VOLTMETER. CONNECT THE GRID OF THE METER TO B- IN THE CIRCUIT AND PLUS ON THE METER TO THE MID-POINTS ON R1, R5 AND R7.

AC Screen Grid Set

By Hector Ambrose

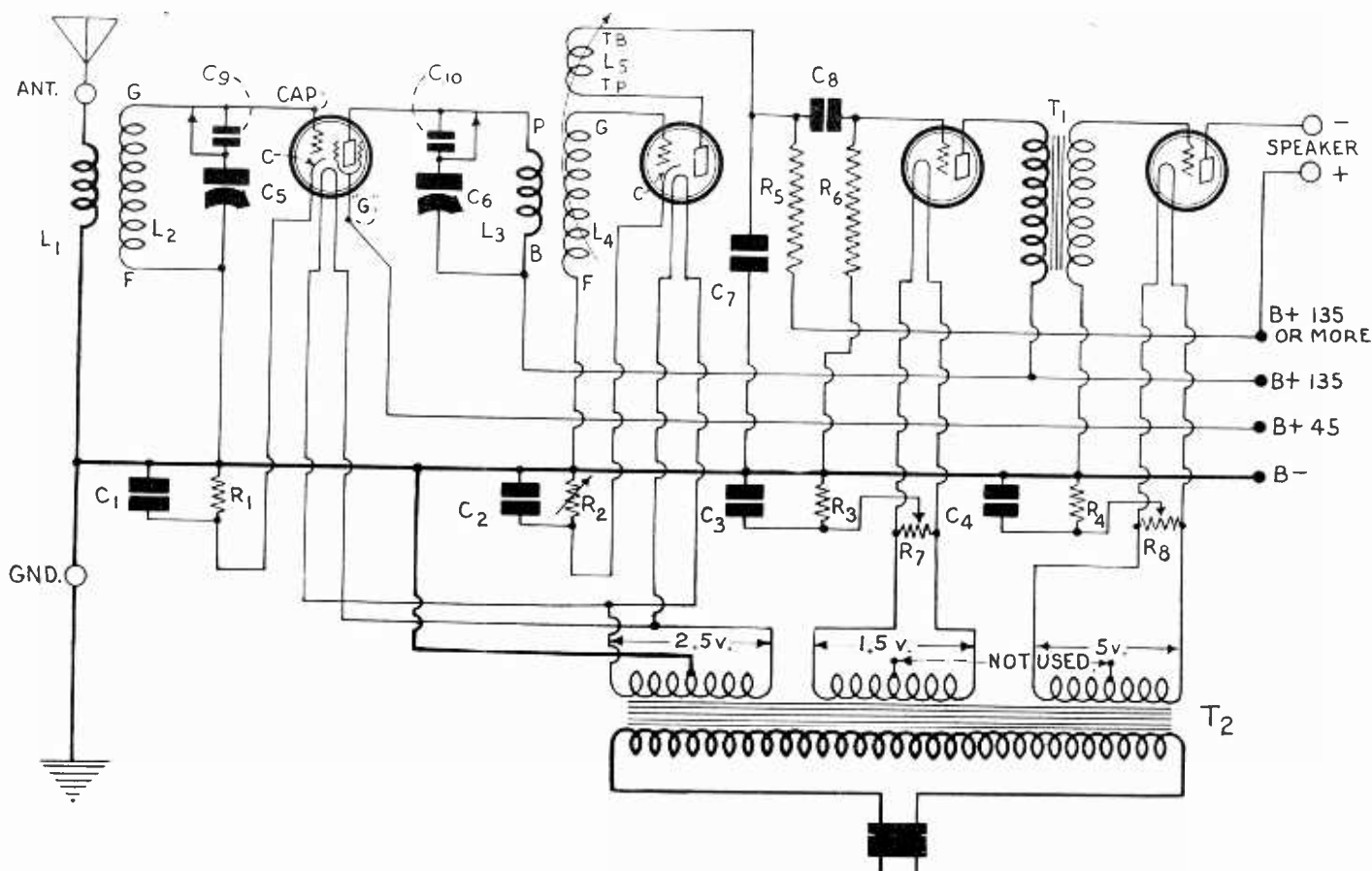

FIG. 1

A FOUR-TUBE ALL-ELECTRIC RECEIVER INCORPORATING AN AC SCREEN GRID TUBE, HEATER TYPE DETECTOR AND TWO AC HEATED AUDIO TUBES (226 AND 171 A).

THERE has been considerable demand for an all-electric receiver incorporating the new AC screen grid tube. A four-tube circuit incorporating such a tube is shown herewith.

The coupling between the detector and the first audio tube is of the resistance type. This is permissible because the heater type tube does not develop a hum even when resistance coupling is used.

Constants of the Circuit

A standard antenna coupler L1L2 is required. Also a three-circuit tuner L3L4L5 is necessary. This is not of the usual design, for the primary L3 is tuned. The three-circuit tuner is therefore of the high impedance type. This has been designed so that the primary tunes with a .0005 mfd. condenser. The secondary L4 is untuned and it contains so many turns that there is a considerable voltage step-up. The tickler L5 contains more turns than the usual three-circuit tuner to insure oscillation, even though a high value resistor R5 is put in the plate circuit.

Unusual Point

The arrangement of the tuning condensers is unusual in that provision has been made for simplifying the tuning on the shorter broadcast waves. Condensers C5 and C6 are of the .0005 mfd. size for tuning. Condensers C9 and C10, in series with the tuning condensers when the switches are open, are .00025 mfd. fixed.

When these series condensers are short-circuited the receiver tunes in the normal broadcast range. When the switches are

List of Parts

- L1L2—One Screen Grid antenna coupler.
- L3L4L5—One Screen Grid three-circuit tuner.
- T1—One National audio frequency transformer.
- T2—One Karas filament transformer.
- C1—One .001 mfd. fixed condenser.
- C2, C3—Two Tobe 2 mfd. condensers type 202.
- C4—One Tobe 4 mfd. condenser type 204.
- C5, C6—Two Hammarlund Midline condensers, .0005 mfd.
- C7—One .0005 mfd. fixed condenser.
- C8—One .01 mfd. fixed condenser.
- C9, C10—Two .00025 mfd. condensers.
- R1, R3—Two Electrad Truvolt 1,500 ohm resistors.
- R2—One Electrad Royalty variable resistor, 0-500,000 ohms.
- R4—One Electrad Truvolt 2,000 ohm resistor.
- R5—One Lynch metallized .25 megohm resistor.
- R6—One Lynch metallized 2 megohm resistor.
- R7—One Carter mid-tapped 20 ohm resistor.
- R8—One Carter mid-tapped 50 ohm resistor.
- Eight binding posts.
- Three Peewee clips, one for the screen grid and two for short-circuiting condensers C9 and C10.

open the tuning from 200 to 350 meters is spread out over the entire dials. Of course, the use of these series condensers is optional, but it enables one to get more distant stations between 200 and 350 meters.

As an aid to regeneration at all settings of the tuning condensers the by-pass condenser C7 is connected in the plate circuit of the detector tube. The larger this condenser is, the more readily the circuit oscillates. But it must not be too large, for if it is the high frequencies in the signal will be suppressed noticeably. The value may be .0005 or a .001 mfd.

The ease with which the circuit oscillates also depends on the value of the coupling resistor R5 and on the plate voltage applied to the low end of this resistor. If R5 is .1 megohm the circuit usually regenerates satisfactorily with an applied voltage of 135 volts. If a higher voltage is used the resistance may be increased to about .25 megohm. It is advantageous to use as high coupling resistor as possible, for the higher the resistance the higher the detecting efficiency and the signal voltage transfer to the next tube, up to about 1.0 meg.

Resistors for Bias

The grid bias for all the tubes is obtained from resistors placed in the plate circuits. One resistor is used for each tube to avoid undesired interstage coupling, and to make it possible to adjust the bias on each tube to the optimum value.

R1 supplies the bias for the screen

grid tube. The bias should be about 1.5 volts. The plate current in that tube at that bias when the plate voltage is 135 volts and the screen grid voltage is 45 volts will be about .9 milliamperes. Thus to get a bias of 1.5 volts the value of R1 should be 1,667 ohms. A commercial unit of 1,500 ohms will be suitable. The resistor should be by-passed by a condenser C1 of .001 mfd. or more.

A rather high negative bias is used on the detector, and this is obtained from the drop in R2. This resistor is made variable because the optimum value of bias is critical and it cannot be predetermined. R2 should have a range from 0 to 500,000 ohms. A condenser C2 of 1 mfd. is connected across this resistor to by-pass both audio and radio frequency currents. If preferred, the bias for the detector tube may be obtained from a C battery connected in the same position as R2. This battery should have a tap at every cell and it should have a maximum voltage of at least 7½ volts. The positive of this battery should be connected

Radio University

A FREE Question and Answer Department conducted by RADIO WORLD for its yearly subscribers only by its staff of Experts. Address Radio University, RADIO WORLD, 145 West 45th St., New York City.

When writing for information give your Radio University subscription number.

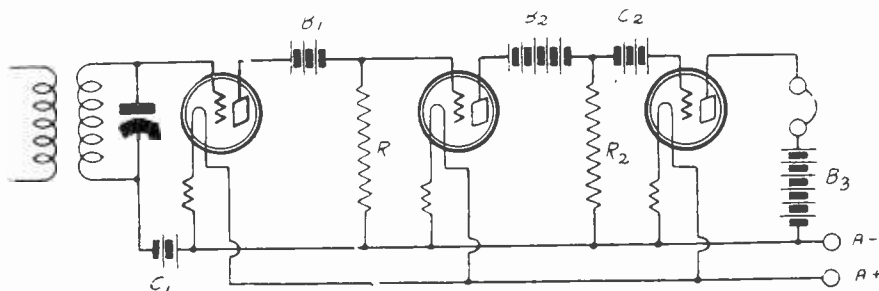

FIG. 711
A CIRCUIT SUITABLE FOR THE AMPLIFICATION OF DIRECT CURRENTS OR CHANGES IN DIRECT VOLTAGES. REQUESTED BY FRITZ RADECKE.

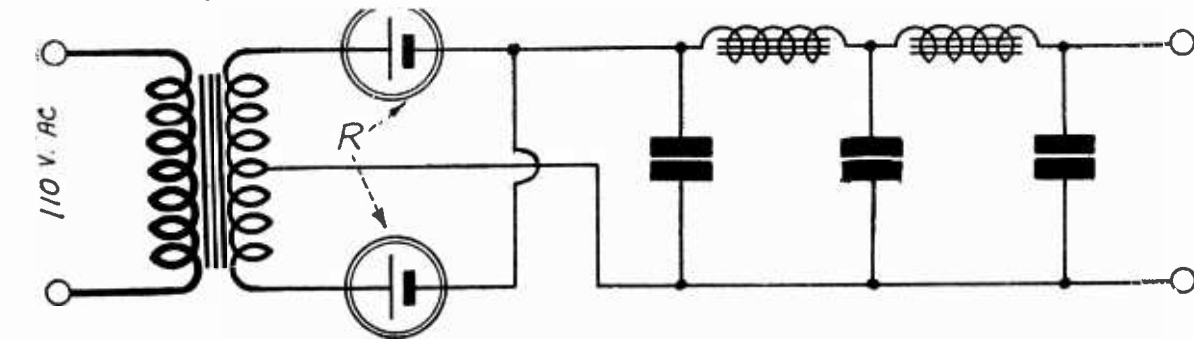

Fig. 712
The circuit diagram of an A battery eliminator. A full wave battery charger followed by a filter consisting of two .5 henry chokes and three 4,000 mfd. electrolytic condensers. Circuit requested by Fritz Radecke.

to the cathode and the negative to the grounded bus bar, that is B minus.

A voltage of about 10.5 volts is required for the first audio tube, which is of the -26 AC type. This bias is obtained from resistor R3, which should have a value of 1,500 ohms. This resistor is by-passed by a condenser C3 of 1 mfd. or higher capacity.

Power Tube Used

The power tube is of the -71A type, which requires a bias of 40 volts when the voltage on the plate is 180 volts. The resistance R4 should then be 2,000 ohms. This need not be changed if the plate voltage is reduced. The condenser C4 should not be less than 4 mfd. although the circuit will work well on 2 mfd.

The two audio tubes require that the plate return be made to the mid-point on the filament, or what amounts to the same thing, to the mid-point of a suitable resistor connected across the filament. R7 across the 1.5 volt winding should have a resistance of 20 ohms, and R8 across the 5 volt winding should have a resistance of 50 ohms. Both should be accurately center-tapped.

The filament transformer used has three windings, one of 5 volts, one of 1.5 volts, and another of 2.5 volts. The heaters of the RF tube and the detector are put across the 2.5 volt winding. Note that the mid-tap on this winding is connected to ground, or to the cathode. This is necessary to eliminate hum.

Although no speaker filter is shown one should be used, unless the last tube is of the -12A type. In that case the speaker may be connected in the plate circuit directly. If this tube is used the resistance R4 should be 750 ohms.

NASHVILLE SHOW IN OCTOBER

The second annual radio show at Nashville, Tenn., will be held at the Hippodrome, October 2, 3 and 4. The show is sponsored by the "Nashville Banner" in collaboration with the radio distributors and dealers, together with the three broadcasting stations, WSM, WBAW and WLAC.

PLEASE PUBLISH a circuit suitable for the amplification of direct current.

(2)—Also please publish a circuit of an A battery eliminator.

FRITZ RADECKE,
Washington, D. C.

(1)—Fig. 711 shows a three-tube amplifier suitable for amplification of direct current. A milliammeter should be put in place of the headset for detecting the changes in the direct current, and the tuned circuit should be replaced by the DC input device. A very small change in the grid voltage on the first tube will result in a very large change in the plate current of the last tube.

(2)—Fig. 712 shows a circuit of an A battery eliminator. The three condensers should be electrolytic and the two choke coils should be of low inductance (.5 henry) and of large current carrying capacity. The transformer and rectifier may be those of a battery charger.

I HAVE ASSEMBLED a C battery eliminator as described in RADIO WORLD June 18th, but I have no means of measuring the output voltage. I cannot tell whether it is 1 volt or 100 volts. When I put high resistance voltmeter across the output terminals I get no indication.

FRANCIS AULT, Evanston, Ill.

A vacuum tube voltmeter is necessary for measuring the output voltage. For this you can use the last tube in the receiver. Put a milliammeter in the plate circuit of that tube and then calibrate the meter by noting the current for various voltages applied to the grid by means of a battery. Then substitute the C battery eliminator for the grid battery and note the current obtained. Compare this with the current obtained with known voltages. When the plate currents are equal the grid voltages are also equal whether the voltage is obtained from a battery or a battery substitute.

Join RADIO WORLD' University Club

And Get Free Question and Answer Service for One or Two years.
This Service Only for Those Who Subscribe by Filling out
This Coupon and Sending Remittance.

Subscribe for RADIO WORLD for one year (52 numbers, one each week) at \$6, or two years at \$10 (104 numbers) by filling out this coupon and enclosing remittance. You will then become a member of RADIO WORLD'S University Club and receive a secret number.

Put this number on the outside of the forwarding envelope (not the enclosed return envelope) and also put at the head of your letter. If already a subscriber, send \$6 or \$10 for renewal from close of present subscription and your name will be entered in Radio University. No other premium given with this offer.

RADIO WORLD, 145 West 45th Street, New York City.
Enclosed find \$6.00 for RADIO WORLD for one year (52 nos.); or \$10.00 two years (104 nos.) and also enter my name on the list of members of RADIO WORLD'S University Club, which gives me free information in your Radio University Department for the period of this subscription, and send me my secret number indicating membership.

Name

Street

City and State

..Renewal () Put cross here if you are renewing subscription.

Screen Shield Ends Life of Two Tubes

By Herbert E. Hayden

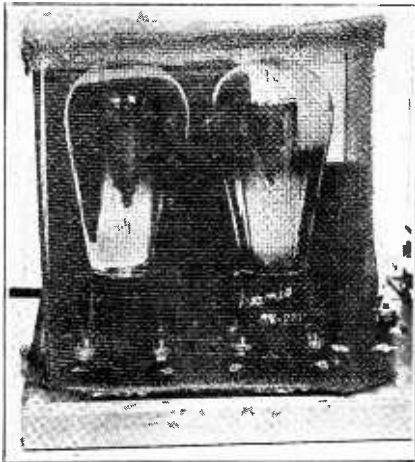

(Hayden)
SCREEN PUT AROUND A PAIR OF
281 RECTIFIERS THAT CAUSED DE-
STRUCTION OF THE TUBES.

There exists around high voltage rectifier tubes and associated equipment an intense electrostatic field which may be

responsible for much hum in the receiver. A grounded wire screen such as is illustrated in the accompanying photograph is an effective remedy for such a field. It surrounds the high tension tubes and leads with a ground through which the electrostatic field cannot pass. Thus all conductors outside the shield cannot pick up any disturbance which might produce hum in the set.

If such a shield is used it is essential that it be made large enough. If placed too close to the tubes or to any of the high tension leads there may be a discharge between the grounded shield and the high tension conductors. This might result disastrously to the tubes. In one case there was a discharge between the shield and the plates of the tubes through the glass which did not stop until the tubes burned out. This would not have happened had the shields been farther away from the plates. The distance between the shield and the nearest point to any of the tubes or any high tension conductor should be at least 3 inches. When that precaution is observed there is no danger and the full value of the shield is obtained.

transmitting station with the control room in Baltimore, for talking purposes. In case the talking circuit should open up, the repeater relays are so arranged that both repeaters will be automatically turned on, so that there will be no interruption to program by the failure of the control or talking circuit.

At the transmitting station, located north of Reisterstown, Md., about thirty kilowatts of electrical power are required to run the transmitter. To supply this power there are available two sources of power from two separate 4,000-volt feeders. A high voltage oil switch is provided at the radio station to change to either source of power in case one should go dead.

Automatic Control

WBAL's transmitter is automatically controlled by interlocking relays, so that when any part becomes defective due to a short circuit, etc., the equipment will automatically be shut down and the power taken off, to avoid damage to the equipment.

During heavy electrical storms, there will be set up heavy voltage surges in the transmitter which cause the 10,000-volt plate supply to arc over, which sometimes causes a break in the program. We have found it necessary, during heavy electrical storms, to have an operator stationed constantly at the high voltage plate supply switch to close the switch again after a heavy flash has occurred.

During a severe electrical storm, the transmitter may arc over a dozen times during an evening, but the operator, by immediately reclosing the circuit, regains normal operation and there is a break in the program so slight that it is generally not noticeable to the listener, especially as there are usually heavy static clicks coming into his receiver at the same time. The three or more foot flash of blue flame that takes place at the station, however, is, I may say, never unnoticed by the operator in the transmitting room.

Feats of Engineers Prevent Interruption

By G. W. Cooke

Engineer-in-Charge, WBAL, Baltimore

In the control room adjacent to the broadcasting studios are located all the circuits and switching relays that take care of the switching of the various microphones, loudspeakers and call devices that are necessary for dual studio operation. It is necessary at all times to have all of the 30 switching relays that accomplish the switching of this apparatus working correctly all the time or there probably will be a break in the program.

As an example of the complexity of the relay system, it may be stated that during a simple switch from one studio where a number has just finished, to the announcing booth where the announcement is to be made, it is necessary that 18 separate relay operations, involving 13 relays, take place. During a normal evening's broadcasting, the total switching during the evening involves approximately 1,800 separate and distinct operations; the failure of any one of these 1,800 operations most probably would result in a break in the broadcast program.

Specially Balanced Circuits

After the broadcast program leaves the studio, via the control system, it is sent to the radio transmitting station, to be put on the air, over special telephone circuits. These circuits go through the regular channels with the subscribers' circuits, but are very specially prepared and balanced to avoid distortion of the voice and music and incidental noises always more or less present in the ordinary telephone wires.

Two of these special circuits are used to carry the program, one circuit being a spare for the other in case of a telephone line failure. In case one program circuit fails during the broadcasting, the control operator at the studio and the sta-

tion operator at the transmitting station both immediately throw their line switch over to the emergency position, and the program will then come over immediately on the spare circuit, resulting in but a slight break or click in the program.

The distance from WBAL's transmitting station to the studio is twenty-one miles, so it is necessary about half-way out to the station to have repeaters, or boosting amplifiers, on the two program circuits, to amplify, or boost up, the volume coming from the studio, before it is again sent on to the station.

No Interruption

These amplifiers, two in number—one for each circuit—are turned on by remote control from the transmitting station about eight miles away by means of special relays.

The current for these relays is carried by a third circuit which connects the

\$500 Reward Offer in Fake Message Case

Washington.

A reward of \$500 for information leading to the conviction of the person or persons guilty of transmitting alleged "false radio messages purporting to have been sent by the 'Greater Rockford' fliers," during the time they were lost in Greenland, has been offered by the American Radio Relay League, comprising 16,000 amateur operators, the League has informed the Federal Radio Commission.

K. B. Warner, secretary of the League, stated that the League is indignant over the occurrence and that it is equally indignant that the newspapers should have stated that the messages emanated from a licensed amateur when there was no justification for this suspicion.

O. K. for Set to Keep Neighbors Awake

Camden, N. J.

"My husband gets up at 4 A. M. to go to work," Mrs. Carrie Samelfiad told City Judge Bernard Bertman, of Camden, "therefore he needs sleep during the night, but Charles Goldie's radio set is going loudest at 1 A. M."

The judge could see no reason why Mr. Goldie, a neighbor, should also sleep because Mr. Samelfiad did.

"This Court stands with the radio enthusiast," said Judge Bertman. "The only thing I can suggest is that you take the complaint to the Court of Chancery."

Instalment Sales of Equipment Heavy

Washington.

Large scale selling of radio equipment on the deferred payment plan is indicated in replies received at the Department of Commerce in the latest quarterly survey of stocks on hand, which show that 4,050 of 5,737 dealers reporting do varying percentages of their merchandising in this way, according to a summary made public by the Department.

Of the 4,050 dealers reporting deferred payment sales, 3,000 do from 50 to 100 per cent of their annual business on this plan, the Department announced. A 100-per-cent deferred payment business was reported by 218 dealers. The statement follows in full text:

"Some 4,050 of the 5,737 radio dealers reporting to the Department of Commerce for the latest quarterly survey of stocks on hand stated that varying percentages of their total sales of radio equipment were made on the deferred payment plan during 1927.

Some Do 100% Deferred

"The remaining 1,687 dealers who returned the general questionnaire either did not answer the specific question pertaining to deferred payment sales or reported that no business was transacted by them on this basis during the year.

"Approximately 3,000 of the dealers reporting their deferred payment sales stated percentages of such business to be between 50 and 100 per cent of the total sales for the year. The remaining dealers advised of transacting between 5 and 45 per cent of their business on the deferred payment plan.

"Some 218 of the dealers included above reported that their total business for the year was transacted on the deferred payment plan. Five per cent of the total business on this basis was reported by 125 dealers.

Pacific's Showing Largest

"The largest percentage of sales of radio equipment on the deferred payment plan were reported by dealers in the Pacific Group—Washington, Oregon, and California. The lowest percentage of sales on this basis was reported by dealers in the North West Central Group—Minnesota, Iowa, Missouri, North Dakota, South Dakota, Nebraska, and Kansas.

"The complete report was compiled by the Electrical Equipment Division, Bureau of Foreign and Domestic Commerce, with the assistance and cooperation of the Radio Division, National Electric Manufacturers Association, and the many individual dealers who voluntarily reported on their business during the year."

MODERNISM



(Hayden)

THOSE WHO FIND FAMILY OBJECTION TO UNSIGHTLINESS OF A STORAGE BATTERY MAY RESORT TO THIS EXPEDIENT—A BOX BUILT TO HOUSE THE BATTERY AND PAINTED IN COLORED DESIGN.

City. Here a National Builders' Service will be operated in conjunction on "The Everyman Four." The original revised and improved model of this fine circuit will be featured as well as the AC model and the new screen grid "Everyman" as exhibited and featured at the Radio World's Fair. Advice to fans will be given on this and other circuits. Power packs and eliminators built to order.

A kit department furnishing tested and guaranteed parts and a completely equipped laboratory will be open for the service of customers. Dynamic speakers will be carried and furnished matched to "The Everyman" sets. This will be the exclusive station on this circuit and also for the well-known Aero products of Chicago.

Sangamo Condensers In Byrd's Equipment

The radio needs of Commander Byrd's Antarctic expedition in the line of standard and high voltage condensers have been supplied by the Sangamo Electric Company of Springfield, Ill. The condensers will be used in the receivers and transmitters carried on the ship and planes of the expedition. The mica condensers are molded in bakelite by the Sangamo process and are immune to thermal and atmospheric changes. They are made in thirty-five capacities, also, 2,500 and 5,000 volts breakdown for high voltage and transmitting purposes. This company makes a complete line of condensers and audio transformers of high quality for single and push-pull modern outputs. Rossiter & Co., Inc., 136 Liberty Street, New York City, are Eastern representatives and will furnish complete information on these lines to all who are interested. When writing, mention RADIO WORLD.—J. H. C.

S-M Line Exhibited by New York Firm

Thousands of enthusiastic fans crowded the showrooms of Rossiter, Tyler & McDonnell, Inc., 136 Liberty Street, New York City, during a recent week for the pre-season showing of the Silver-Marshall line for 1929. All the new Silver-Marshall receivers—the 720, the Round the World Four, the new Sargent Rayment Seven, the Coast to Coast four, the line of Unipacs, the new public address Unipacs, the new Clough system Silver-Marshall audio transformers, etc., were shown. F. Edwin Schmidt, Silver-Marshall's metropolitan representative, headed the corps of courteous demonstrators. Mr. McDonnell will be glad to answer any inquiries as to these new products. Address Frank McDonnell, care of Rossiter, Tyler & McDonnell, Inc., address above, and mention RADIO WORLD.—J. H. C.

Moore Radio Co.

E. Bunting Moore, of "Everyman Four" fame, and formerly technician of Radio Kit Co., has founded the Moore Radio Co., with headquarters at suite 301, at 72 Cortlandt Street, New York

TRIES OUT AS ANNOUNCER



HERMAN BERNARD, MANAGING EDITOR OF RADIO WORLD, ACTED AS GUEST ANNOUNCER ONE RECENT NIGHT AT WGBS, THE GIMBEL BROS. STATION IN NEW YORK CITY. WITH HIM IS SHOWN THE WGBS STRING QUARTETTE (L. TO R.) IVAN ARGAY, FIRST VIOLIN; JOHN KOKES, SECOND VIOLIN; FREDERICK CAMELIA, CELLO; ANTONIO BORELLO, VIOLA.

PARTS IDENTIFIED FOR A TELEVISION RECEIVER

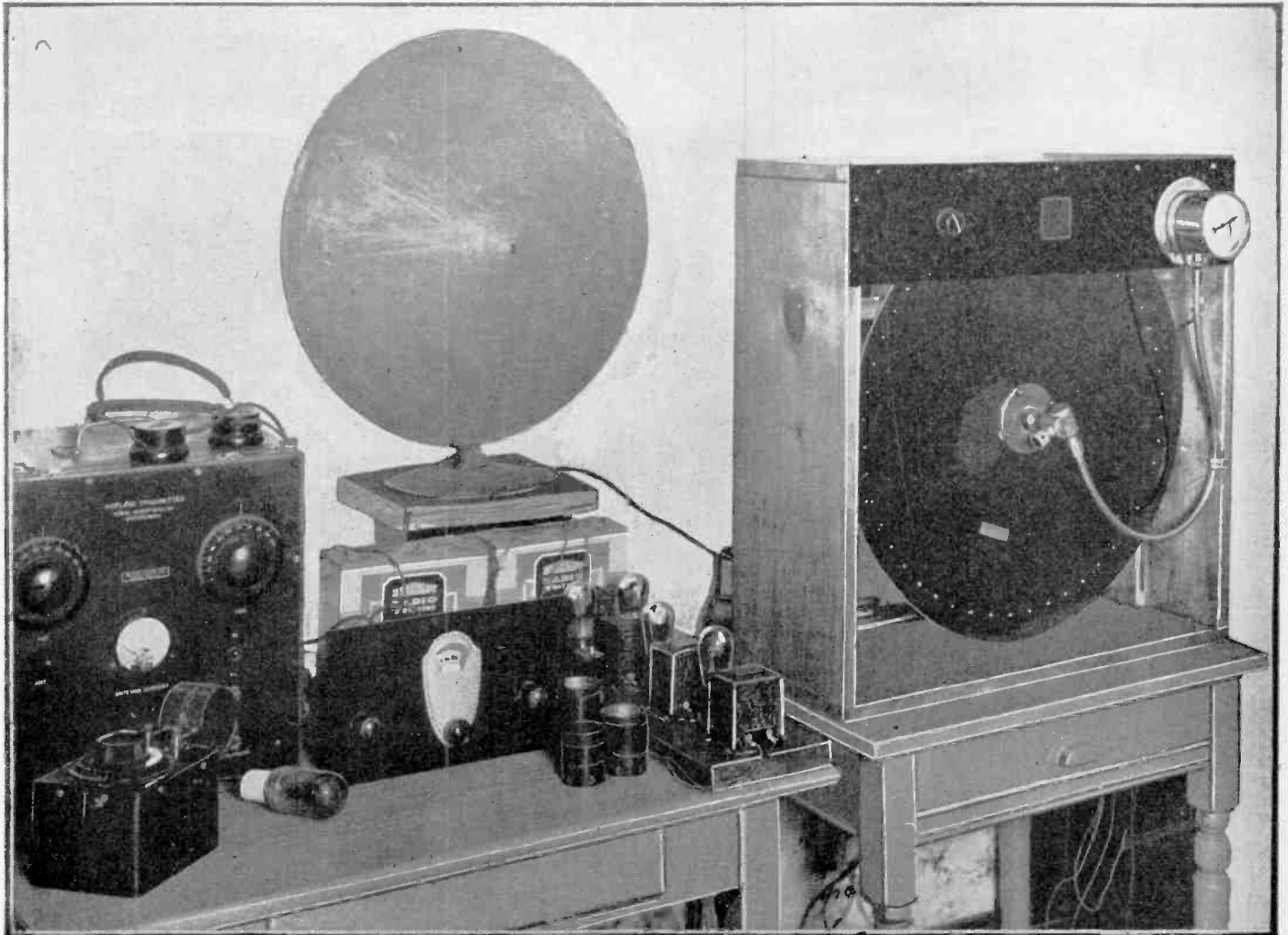

AT RIGHT IS THE SCANNING DISC, TACHOMETER WITH CABLE ATTACHED, PEER WINDOW AND SPEED REGULATOR. A HOOD FOR THE PEER WINDOW IS ADVISABLE (NOT SHOWN). THE SPEAKER IS KEPT IN CIRCUIT AS A TUNING AID. THE NATURAL SHORT-WAVE SET IS IN CENTRAL FOREGROUND, BEHIND THE PLUG-IN COILS. THE APPARATUS AT LEFT HAS NOTHING TO DO WITH TELEVISION. THIS IS THE OUTFIT JAMES MILLEN USES TO RECEIVE TELEVISION

WHEN SOLDERING TRY THIS

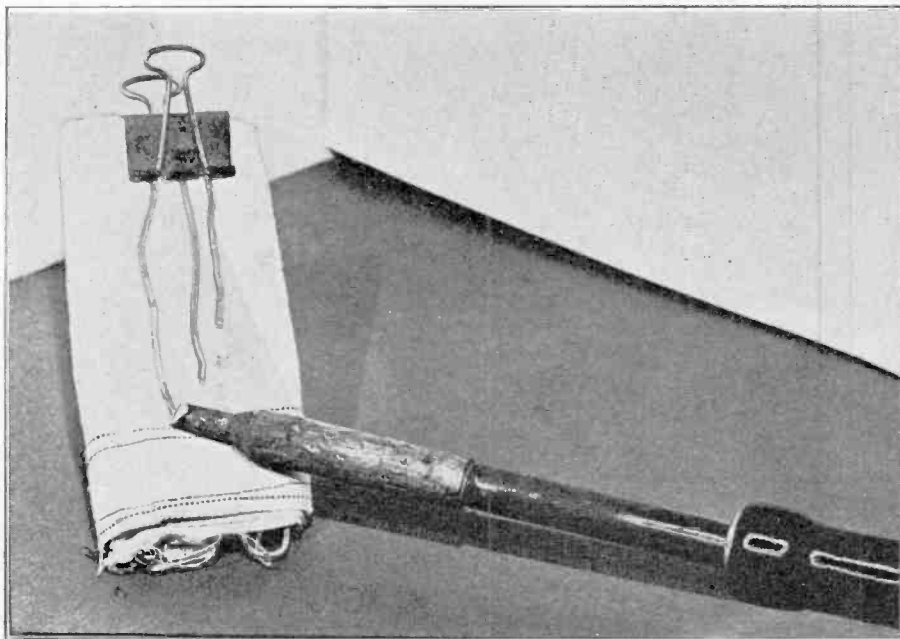

(Hayden)

A HANDY COMBINATION FOR SOLDERING WITH ROSIN-CORE IS MADE OF AN OFFICE CLIP AND SOME FOLDED ASBESTOS. THE SOLDER MAY DRIP WITH IMPUNITY. ALSO, YOU MAY WIPE THE IRON CLEAN ON THE ASBESTOS. SOLDER SHOULD BE APPLIED AT THE JOINT, RIGHT FROM THE STRIP, BUT AS MANY INSIST ON "CARRYING IT OVER," THE ABOVE PROTECTION IS SUGGESTED

O'BRIEN'S CULTURE



"P. J." O'BRIEN

"Philadelphia Jack" O'Brien, former champion pugilist, is giving health exercises from WRNY, the "Radio News" station, every day. He has some famous folk follow in the studio the same directions that issue forth over the air. His physical development teachings have brought him many complimentary letters. He runs a "gym" for a living.

New Corporations

Expert Radio Corp.—Atty., Steinfeld & Natapoff, 1548 Westchester Ave., N. Y. City.

Harvard Radio Corp.—Atty., L. D. Schwartz, 150 Nassau St., New York City.

Southern Radio Corp., Wilmington, Del.—Atty., Corporation Trust Co. of America, Wilmington, Del.

Rebuilt Earphones Co.—Atty., W. J. Bloom, 245 Fifth Ave., New York City.

Vassar Radio Shop—Atty., C. Husted, Poughkeepsie, N. Y.

Hermox Radio Stores—Atty., Weber & Goldstein, 220 Broadway, New York City.

Carteret Radio Laboratories—Atty., S. Fine, 165 Broadway, New York City.

Photo-Television Corp.—Atty., J. Lew, 299 Broadway, New York City.

The New A-C Victoreen

By E. A. Benson

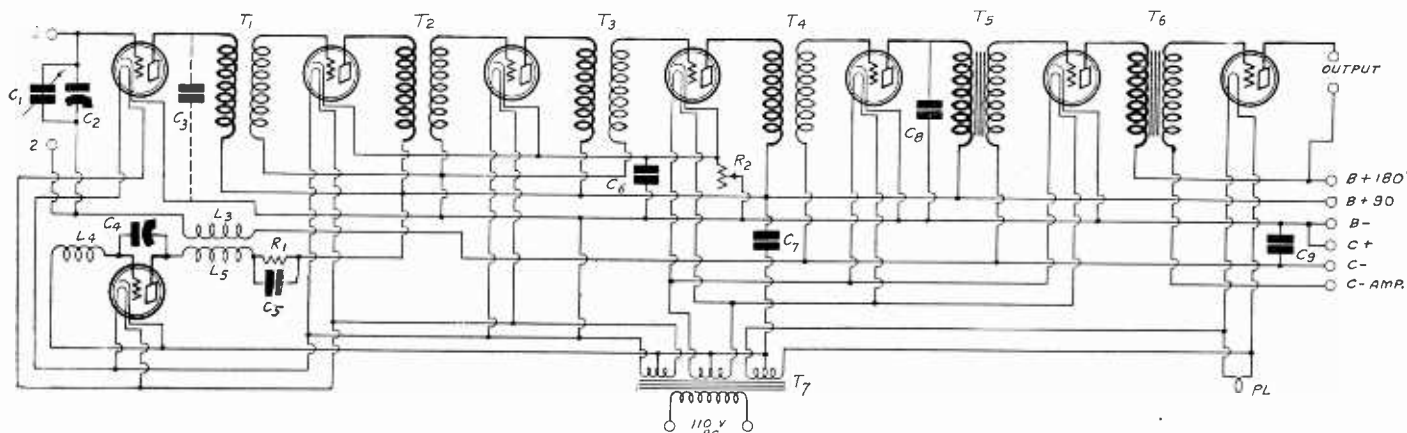

THE CIRCUIT OF THE NEW AC VICTOREEN, 1929 MODEL

[The first presentation of the new AC Victoreen was begun in last week's issue, dated September 22. Herewith assembly, wiring and tuning details are given, as well as some service data. Next week the power supply will be discussed. Both the receiver and the power supply attracted much admiration at the recent Radio World's Fair in New York City. Actual demonstrations, given during the show week, proved this model to be even better than the DC Victoreen model, so popular for more than three years.]

THE construction of the set itself is very simple. The panel may be obtained ready drilled and engraved to meet the requirements of the circuit. But if the builder decides to drill his own panel he may do so by drilling only a few holes, the exact locations of which may be obtained from the full-sized template printed on the reverse side of the blue print. I will be glad to supply a complimentary blueprint. Address me care RADIO WORLD, 145 West 45th Street, New York City.

The single dial control unit, as stated previously, is not absolutely essential to this circuit, but if it is not used, two separate dials and Remler condensers must be substituted, which also must be placed in the same relative positions on the panel as shown in the print.

Testing Parts Before Mounting

Regardless of the care taken in the manufacture of the individual parts there is always a chance of damage in transit. Before you assemble any of the transformers or condensers in the receiver test out with a battery and voltmeter to be sure that there are no open circuits in the transformers or any short-circuits in the condensers.

The actual wiring of the receiver is exceptionally simple if the printed wiring directions are carefully followed. These directions, which are furnished, are of the point-to-point type. That is, they are explicit and unmistakable.

If you have followed the blueprint carefully your wiring will be correct. It is wise, however, where the possibility of blowing out eight tubes is concerned to check up your instructions once more

to make sure you have made no mistakes and insert but one tube at a time with power on.

Adjusting the Loop Circuit

The Victoreen No. 152 oscillator is adjusted at the factory, so that there is but little difference in condenser settings for given stations.

The small compensating condenser has been added to compensate for different types of loops, and the capacity of this small condenser has been chosen, of such value, that the rotor plates are not quite half into the stator plates when in operation under normal conditions. Therefore, the number of turns on the loop should be so adjusted that the condenser is in this position.

If the small condenser plates give maximum signal strength with the condenser plates entirely open, one or two turns should be removed from the loop and vice versa. This may be accomplished by making a bare spot in each of the last two or three turns on the loop, using a clip to determine the proper number. Before attempting this, however, be sure that both Remler condensers are operating in exactly the same position.

Tuning the Receiver

Tune in a local station in order that the approximate position of the compensator and volume control can be determined.

The tuning is sufficiently critical so that quality will not be obtained unless

both the dial and compensator are adjusted to the center of the maximum volume point. The volume may now be reduced to its desired value by means of the right hand knob on the panel.

When tuning for distant stations, tuning is accomplished in a somewhat different manner. The volume control is first increased until the usual rushing sound is heard, indicating the receiver is increasing in sensitivity. Next, adjust the compensator to its maximum volume point. The tuning dial is then very slowly revolved until a station is heard. The compensator is then tested and the volume increased by the volume control.

Either loop or aerial may be used on this set. To use the antenna it is merely necessary to remove the loop leads and connect the antenna coupler secondary to the loop posts as shown on the blueprint.

Service Hints

Regeneration is not recommended with this circuit as the selectivity of the loop circuit is much greater than is usual and the circuits might become unbalanced if regeneration were used.

The C bias, as before explained, must be carefully adjusted. You may try nine, 10½ or 12 volts to determine which gives the best quality of reception. Thereafter, make sure this value is maintained. The C bias for the UX 250 power tube is not critical and 90 volts will generally be found satisfactory with Victoreen Power Supply.

Literature Wanted

John M. Green, 227 4th Ave. S., Franklin, Tenn.
T. Lama, Suite 15, Stanley Bldg., Main St., Win-
nipeg, Man., Canada.
R. D. Suttentfield, 312 N. Clay St., Salisbury, N. C.
H. Borland, 184 Gladstone Ave., Ottawa, Ont.,
Canada.
G. R. Squires, 2810 Madison St., Kansas City, Mo.
W. Leonard Carver, 117 Cockerille Ave., Takoma
Park, Md.
J. L. Bundy, 3 North Addison St., Richmond, Va.
R. G. Livingstone, Wallace, Idaho.
Edmund L. Maher, 429 Autmn Ave., Brooklyn,
N. Y.
J. R. Peden, 709 Teetshorn St., Houston, Texas.
P. F. Engelman, 7 Ashley St., Dayton, Ohio.
S. Wallace, 2575 8th Ave., New York City.

Louis Marko, 157 Hope Ave., Passaic, N. J.
Eugene Sacks, 315 N. Grant Ave., Indianaopolis,
Ind.
Roy L. Smith, 201 West High St., Lexington, Ky.
W. C. Depp, 634 North 15th St., Muskogee, Okla.
Harry A. Kentzel, 533 Clearview Road, Manoa,
Del. Co., Pa.
S. G. Peticolas, General Delivery, Stelton, N. J.
Wm. Gilfoy, 160 So. Pearl St., Albany, N. Y.
A. Theodore (Theodore Radio Service), 2049 St.
James St., Montreal, Canada.
A. E. Binder Mfg. Co., 73 Ivy St., Atlanta, Ga.
Radio Circular Co., Inc., 225 Varick St., New
York, N. Y.
R-C Radio Laboratories, Inc., 815 Madison Ave.,
Toledo, Ohio.

YOU MUST GET THIS BOOK!



DRAKE'S RADIO CYCLOPEDIA (New Edition)

has been developed to answer the questions of service men, custom set builders and home constructors, of experimenters, students, salesmen and operators of receiving equipment and to allow all these to have instant access to the information they want. The author, Harold P. Manly, has collected and translated into plain English the material formerly obtainable only from dozens of scattered sources.

BOOK IS 2 1/2" THICK. WEIGHS 3 3/4 LBS., 1,025 ILLUSTRATIONS.

name under which the information might be classed.

This alphabetical arrangement lets the experienced worker refer directly to the one thing in which he is interested at the moment without hunting through non-essentials. The needs of the beginner are cared for.

The important articles deal primarily with receivers and reception. They do not stop with the electrical end, but go also into the mechanics of construction. Every new thing in radio is covered in detail.

1,660 Alphabetical Headings from A-battery to Zero Beat
1025 Illustrations, Diagrams, Layouts and Graphs
920 Pages, Each 6 by 9 Inches
240 Combinations for Receiver Layouts

OF THE PRINCIPAL ARTICLES

159 concern service men, 129 help the set builder, 162 help the experimenter, 155 interest the student, 75 assist in sales work, 73 interest set owners.

Radio World: "The most suitable volume for those who want the facts strung as far as possible of intricacies. Useful addition to any library."

Radio Broadcast: "The reviewer does not believe that a more satisfactory addition to the experimenter's library in any one volume can be made."

QST: "The information is so put as to be of most immediate use to the constructor and repair man, and, remarkably enough, includes apparatus of most recent origin."

Radio: "Selfdom is any subject so comprehensively and practically explained."

GUARANTY RADIO GOODS CO.

145 W. 45th St., New York, N. Y. (Just E. of B'way)
Gentlemen: Please mail me at once the new (second) edition of "Drake's Radio Encyclopedia," by Harold P. Manly, just published, with all the latest technical information in it. I will pay the postman \$6.00 plus a few cents extra for postage. If I am not delighted, I may return the book in five days and you will promptly refund my purchase money.

Name

Address

City State

5-DAY MONEY-BACK GUARANTY!

RADIO WORLD, published every Wednesday, dated Saturday of same week, from publication office, Hennessy Radio Publications Corporation, 145 West 45th Street, New York, N. Y., just east of Broadway. Roland Burke Hennessy, President; M. B. Hennessy, Vice-President; Herman Bernard, Secretary. Roland Burke Hennessy, Editor; Herman Bernard, Managing Editor; J. E. Anderson, Technical Editor; Anthony Sodaro, Art Editor.

BIG OFFER!

Radio World for Four Weeks **50c**

Blueprint FREE!

of 4-Tube Screen Grid Diamond of the Air

At 15c per copy RADIO WORLD costs you 60c for four weeks. But if you send 50c NOW you get the first and only national radio weekly for four consecutive weeks and a blueprint FREE!

This blueprint is life-sized and shows in easy picture diagram form how to mount parts and wire this super-sensitive receiver. One screen grid tube is used as radio frequency amplifier. The rest of tubes are two—01A and one 112A.

This circuit gives you distance, tone quality, ease of performance. No shielding, no neutralizing required!

ACT NOW!

This offer holds good only until November 30th and coupon below MUST be used as order blank.

Radio World, 145 West 45th Street, New York City

Enclosed please find 50 cents (stamps, coin, check or money-order) for which please enter my name on your mail subscription list for the next four issues of RADIO WORLD, and send me FREE at once a blueprint of the Four-Tube Screen Grid Diamond of the Air (front panel and subpanel wiring, schematic diagram and parts list.

Name

Address

City State

Renewal.

If you are a mail subscriber for RADIO WORLD you may extend your subscription four weeks. Put a cross in the square in front of the word "renewal," to show you are a subscriber already.

Where Waves Are Short And Distances Long

The mystery and magic of the short wave region, down below the Broadcast band, is gaining converts by the thousands. Short-wave receivers and adapters have gained great favor. London, Holland and Russia are being heard by DX veterans, who now scorn "coast" receptions, which they once boasted of as a great achievement.

However, bringing in the short-wave stations successfully requires the most expert and careful tuning as it is a more difficult matter than tuning in the regulation broadcast receiver.

Short waves are exceedingly high frequencies, the dials are razor sharp and it therefore becomes more than a mere matter of twirling the dials. It is of high importance that the grid leak value should be exact and regeneration must be brought to a maximum peak, at the same time being easily controlled. A Grid Leak Clarostat is an invaluable aid in this instance and many fans are finding it so. It gives an exact resistance range of 1/10th to ten megohms in several turns of the knob, is neat, compact and easily mounted on the panel or baseboard.—J. H. C.

Complete Kit of Parts as Specified by H. B. Herman for 4-Tube

SCREEN GRID DIAMOND \$39.50

BLUEPRINT FREE WITH EACH KIT!

Kit consists of Hammarlund HR 23 coils, Karas tuning condensers and audio transformers, four Amperites, Clarostat, Yaxley switch and pilot bracket with lamp, aluminum subpanel with sockets on, drilled front panel, Lynch leak, Aerovox fixed condensers, Mar-co dials, Pee-wee clip, Vac-Shield, binding posts.

Custom Set Builders Supply Co.
57 Dey Street, N. Y. City

Bakelite Front and Aluminum Subpanel

for the

4-Tube Screen Grid

DIAMOND OF THE AIR - -

\$5.00

Five-Day Money-Back Guaranty

Finest eye appeal results from construction of the 4-tube Screen Grid Diamond of the Air when you use the official panels. The front panel is bakelite, already drilled. The subpanel is aluminum, with sockets built-in, and is self-bracketing. Likewise it has holes drilled in it to introduce the wiring, so nearly all of it is concealed underneath set. Make your set look like a factory job.

Front panel alone, bakelite, drilled.....\$2.35

Aluminum subpanel alone, drilled, with sockets built-in..... 3.00

Screws, nuts and insulating washers supplied with each subpanel.

GUARANTY RADIO GOODS CO.

145 WEST 45TH STREET

NEW YORK, N. Y.

[A few doors east of Broadway]

Quick Action Classified Ads

Radio World's Speedy Medium for Enterprise and Sales

10 cents a word — 10 words minimum — Cash with Order

FREE BLUEPRINTS! GET YOUR SHARE!

National Short Wave Circuit blueprint, exact circuit used by James Millen for tuning in television, voice, code, music, programs. National Screen Grid Five (broadcast receiver circuit) blueprint FREE also. John F. Rider's B Eliminator blueprint free. Send separate request for each of the above free blueprints you desire. Custom Set Builders Supply Co., 57 Dey Street, N. Y. City.

EXCELLENT unit for phonograph attachment, to play records. Connects to speaker terminals, nozzle to phonograph, \$4.20. P. Cohen, 236 Varet St., Bklyn., N. Y.

CHOKES, Condensers, resistances and transformers for eliminators, television and special circuits, also made to your specification. M. C. MFG. CO., 1215 Gilbert Place, New York City

ARTISTS and Art Students are printing 250 signs or pictures an hour without machinery. Sample and particulars 10c. Straco, 1014 Mulberry, Springfield, Ohio.

Recent Issues of RADIO WORLD, 15 cents each. Any number published in 1928 available for a short while. Six issues 75 cents, 10 issues \$1.00. Send stamps, coin or money order NOW, before the issues are sold. RADIO WORLD, 145 West 45th Street, New York City.

QUICK SERVICE. Order radio goods now, shipments made day following receipt. All merchandise pre-tested. Set of Screen Grid Coils for Bernard's Economy Three, consisting of antenna coil Model 2A and High Impedance Tuner, Model 5 HT, \$4.75. One screen grid tube, one high mu tube, one -12A tube, total for three tubes, \$7.00. Blueprint for Bernard's Economy Three, \$1.00. Front panel and subpanel for 4-tube Screen Grid Diamond of the Air, \$5.00. All merchandise guaranteed on five-day money-back basis. Send remittance and I pay carrying and shipping charges. Philip Cohen, 236 Varet Street, Brooklyn, N. Y.

League Plans Station to Address the World

Washington
Plans for the establishment of a high-powered radio station at Geneva, Switzerland, to be used in times of emergency by the League of Nations to send messages to all countries of the world, are nearing completion, according to a note from the Swiss Government to the League of Nations, a copy of which has recently been received by the Department of State.

The radio station normally will be operated by the Radio-Suisse, a company operating under the Swiss Government, but in times of emergency it will be taken over by the League, according to the Swiss note.

Equipment will consist of a transmitter of 50-kilowatt power, and will be capable of reaching all countries in Europe, North Africa and the Near East on long wavelengths. This equipment has already been purchased, while short wavelength equipment soon will be purchased, the League states.

* * *

Geneva, Switzerland
Objection to a League wireless was voiced before the Third Commission by

Great Britain and Switzerland. Great Britain questions the necessity of such expenditure. Switzerland asks how its neutrality would be safeguarded in a war between other nations, since Switzerland must retain jurisdiction over the station. Use of secret code by the League was one answer to this objection.

LYNCH

Television Amplifier Kit Assures Best Results

For quality reception from your television apparatus equip your receiver with an efficient amplifier. You can do so quickly and cheaply with a Lynch 3-stage resistance-coupled amplifier kit. \$9.00 complete. See your dealer.

Send for free book.

ARTHUR H. LYNCH, INC.
1775 Broadway New York City



VICTOREEN
Super Coils

Geo. W. Walker Co.
2825 Chester Avenue
Dept. B Cleveland, O.

SPEAKERELAY

Cat. No. 121

\$2



For connecting two speakers by turn of knob so that at No. 1, left, you operate one speaker alone; at No. 2 you operate both speakers together; at No. 1, right, you operate the other speaker alone. Excellent for store demonstrations or home use. Earphones may be substituted for one speaker.

GUARANTY RADIO GOODS CO.
145 WEST 45TH STREET
NEW YORK CITY Just East of Broadway

PARTS FOR

ECONOMY THREE \$20.41

Exactly as Specified by
HERMAN BERNARD

This astounding circuit can be built just as the designer built it at \$20.41. Here's what you get:

| | |
|---|--------|
| One Screen Grid Antenna Coil..... | \$1.75 |
| One Screen Grid 3-Circuit Coil..... | 3.00 |
| Two .0005 variable condensers (\$1.50 ea.) | 3.00 |
| Six switches (13 $\frac{1}{2}$ c ea.)..... | .80 |
| 20-ohm fixed resistor..... | .25 |
| 10-ohm rheostat with knob..... | .65 |
| 2-ohm fixed resistor..... | .35 |
| Three .00025 mfd. fixed (45c ea.)..... | 1.35 |
| One metallized resistor, .1 meg..... | .50 |
| One metallized resistor, .5 meg..... | .60 |
| One 5-lead cable..... | .50 |
| One 7x18 drilled eng. front panel..... | 2.00 |
| One 7x14 drilled, eng. subpanel with sockets mounted..... | 3.00 |
| Two dials (65c ea.)..... | 1.30 |
| Two tip jacks (15c ea.)..... | .30 |
| Four binding posts [Ant., Gnd., two C minus] (10c ea.)..... | .40 |
| One knob..... | .10 |
| Two subpanel brackets 1-inch high (18c each)..... | .36 |
| \$20.41 | |

Harmonique tubes specified for Economy 3. Tubes not included in above list but cost you extra

| | |
|------------------------|--------|
| 222 (Screen Grid)..... | \$3.50 |
| 240 (high mu)..... | 1.50 |
| 112A (power tube)..... | 2.00 |

Voltage Supplies

| | |
|---|---------|
| B eliminator delivering more than 135 v. to Economy 3 with Raytheon tube..... | \$16.00 |
| A eliminator, dry plate type..... | 22.00 |
| C battery, 7 $\frac{1}{2}$ v..... | .90 |
| 6-v. storage battery with dry charger and relay..... | 14.00 |

Custom Set Builders Supply Co.
57 Dey Street, New York City

BLUEPRINT

FOR

Bernard's Economy 3

Price \$1.00

PHILIP COHEN
236 VARET STREET
BROOKLYN, N. Y.

HARMONIQUE

RADIO TUBES

NOT since Dr. Lee De Forest invented the three-element tube has there been any tube development to compare with the four-element, Screen Grid Tube. But the tube must be expertly made—absolute precision. Then only do you realize the full gain. More distance, more volume, better tone. Instead of a gain of 8 or 10 per stage you can get from 50 to 240 with Screen Grid Tubes.

Harmonique 222 Screen Grid Tube, made with special attention to utmost precision and high amplification. Net price..... **\$3.50**

MONEY-BACK AND REPLACEMENT GUARANTEE

The strength of the guarantee measures the value of a tube. Only the best tubes can be given the best guarantee. All Harmonique Tubes are manufactured scientifically, carefully, expertly, and all are of the first order of merit. Hence all carry the same guarantee—**Money Back** if, after a five-day trial, you are not thoroughly delighted. **FREE Replacement** up to fifteen days after the date of receipt of tube, even if you "blow out" the tube.

THE HARMONIQUE LINE OF TUBES

Here is the full list of tubes to select from, always with the assurance you are getting an extraordinarily good tube, and at a very modest price, due to sale direct to you. The prices are net and include all charges. You don't have to pay postage.

| | | | | | |
|-----------|--------|-----------------------------|--------|----------|--------|
| 201A..... | \$1.00 | UX199..... | \$1.25 | 240..... | \$1.50 |
| 200A..... | 2.00 | UV199..... | 1.25 | 222..... | 3.50 |
| 112A..... | 2.00 | UV199 (standard socket).... | 1.25 | 280..... | 3.50 |
| 171A..... | 2.00 | 226AC..... | 2.00 | 281..... | 5.00 |
| 112..... | 1.85 | 227AC..... | 3.50 | 210..... | 6.50 |
| 171..... | 1.85 | | | 250..... | 8.50 |

NOTE: 112 and 171 specially designed for AC filament heating. The 240 has a mu (amplification factor) of 31. The 112, the 171, the 210 and the 250 sold in tested pairs for push-pull, if desired.

NO DEALERS SUPPLIED

KELLY TUBE COMPANY

8718 RIDGE BOULEVARD, BROOKLYN, N. Y.

—SEND NO MONEY!—

Kelly Tube Company, 8718 Ridge Boulevard, Brooklyn, N. Y.

Please mail me at once the following Harmonique tubes, guaranteed by you against damage in shipment, and on a 5-day money-back guarantee and 15-day FREE replacement guarantee, at advertised prices, which are net. You pay shipping costs.

| | | |
|----------------|----------------|-------------------------|
|Type..... |Type..... |Type..... |
|Type..... |Type..... |Pair.....Push Pull |

NAME..... ADDRESS.....

CITY..... STATE.....

Stroboscopic Tricks Delight Experimenters

While the main purpose of a television lamp is for the reception of television signals, it has numerous experimental possibilities which are certain to appeal to the inventive.

Prime among these is that of stop-motion or stroboscopic observation, which means the apparent slowing down or stopping of the motion of moving mechanism by means of an intermittent light source properly timed to the action of the mechanism to be observed.

Reciprocation Wanted

Thus it becomes possible to see how a balance wheel of a clock goes about its function, or how similar mechanism of the reciprocating or revolving order operates.

The set-up is simple enough. The lamp must be highly sensitive and responsive, with considerable luminosity for proper illumination of mechanism to be observed. The Raytheon Kino-Lamp appears most satisfactory, since it pos-

sesses the necessary sensitivity, responsiveness, and a glowing cathode 1½ inches square which sheds considerable light.

The lamp is connected across a 2 mfd. condenser and to the 180 volt output of a typical B-eliminator, in series with a suitable variable high resistance of at least 0-500,000 ohms, so as to reduce the applied voltage to any desired degree.

Blinks and Flickers

The lamp will blink or flicker intermittently at the lower voltages, and the rapidity of flicker may be controlled by the variable resistance. If the lamp is employed in the dark, its intermittent flashes may be employed to illuminate moving mechanism. As the flashes are brought into step with the observed mechanism, the apparent movement may be slowed down and even brought to a dead stop, as desired.

Many puzzling operations can be readily solved with this simple home-made stroboscope.

Ehrenfried Opens Laboratory Store

George Ehrenfried, 3752 Eighty-ninth Street, Jackson Heights, New York City, has opened a store and laboratory at that address. He has on tap ready information and advice on anything in radio.

He has had many years of experience in radio on sea and land. He has been with the Marconi Company, Freshman, Radio Corporation of America and Fada. He makes tests and also builds a whole installation to order. He is also specializing on matching the new dynamic speakers to the outputs of old and new sets. For any advice and help address George Ehrenfried at above address, mentioning Radio World.—J. H. C.

COMPLETE ADVANCE STATION LIST

Sept. 22 issue of RADIO WORLD contained complete advance list of stations compiled according to the new allocation plan of the Federal Trade Commission, effective Nov. 11. Mailed for 15c a copy, or send \$1.00 for trial subscription of 8 weeks, starting with Sept. 22 issue. RADIO WORLD, 145 W. 45th St., N. Y.

New Powertone Unit Brilliant to Eye and Ear! 1929 Model Far Excels Anything Else in Its Price Class!

Having won highest repute last season, the Powertone Unit, which gave maximum volume and quality reproduction at lowest price, again wins leadership because, without any increase in price, it assures still better performance.

The coil is wound a new way, with double the former impedance, giving remarkably faithful low-note reproduction, a region in which many units are deficient. The middle and high notes are faithfully reproduced, too.

GOLD AND VAN DYKE

The magnet is gold-dipped, giving it a rich and handsome appearance. The dipping is done before the "horseshoe" is magnetized, so there is no detrimental effect on flux. The back frame is sprayed with a Van Dyke finish—deepest brown, a splendid color combination. Imagine gold against Van Dyke! Use this unit for its superior performance and fetching appearance!

WHAT YOU GET:

At \$3.75 each, this unit represents the utmost you can obtain at anywhere near this price. Not only do you get the unit, but also a mounting bracket, apex, chuck, thumbscrew nut, and 10-foot cord.



This unit will drive any type of cone, airplane cloth, linen or similar speaker, but will not work a horn. The Powertone Unit will stand 150 volts without filtering and is fully guaranteed against ALL defects for one year. The armature is adjustable to power tube impedance. Order a unit NOW!

SEND NO MONEY!

Just order one new Powertone Unit with equipment. It will be mailed at once C. O. D. You will pay postman \$3.75 plus a few cents extra for postage.

Try it for five days. If you don't think it superb, simply return the unit with a letter asking for refund, and your purchase money will be returned immediately! You run no risks! All you can do is win!

36" OR 24" KIT

You can use this unit on any type cone or other diaphragm speaker you prefer. If you want to build a 36" or 24" cone yourself, specify which, and unit, paper, bracket, apex, nut, thumbscrew, cement, pedestal, cord and instructions will go forward at \$6.00 C. O. D. plus small cost of cartage.

You will be overjoyed with the new 1929 model improved Powertone Unit. Order one TO-DAY!

GUARANTY RADIO GOODS CO., 145 W. 45th St., New York City. Just East of Broadway

FILL OUT AND MAIL NOW SUBSCRIPTION BLANK

RADIO WORLD

RADIO WORLD

145 West 45th Street, New York City
(Just East of Broadway)

Please send me RADIO WORLD for months, for which
please find enclosed

SUBSCRIPTION RATES:
Single Copy\$.15
Three Months 1.50
Six Months 3.00
One Year, 52 Issues 6.00
Add \$1.00 a Year for Foreign
Postage; 50c for Canadian Post-
age.

Manufacturers of
highest quality
condensers and
resistors
that are—
Built to
Endure!

AEROVOX
"Built Better"
12 WASHINGTON ST., BROOKLYN, N.Y.

Write
for the
Research
Worker, a
free monthly
publication.

New Coils Produce Revolutionary Results!

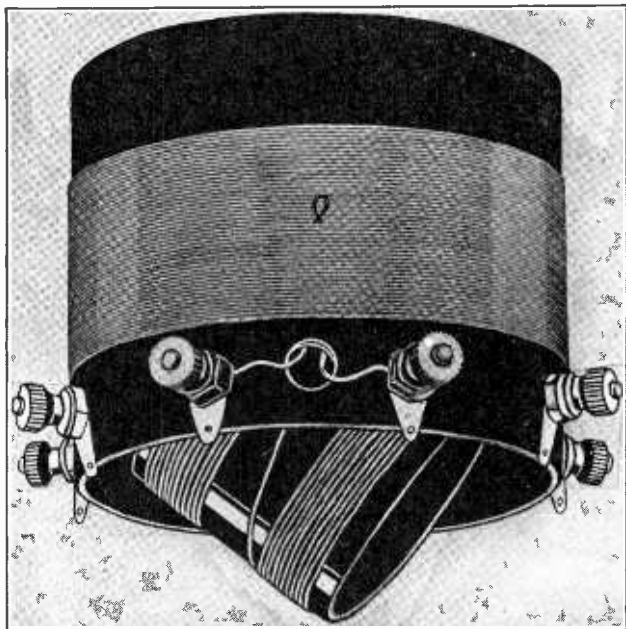

High Impedance Screen Grid Tuner, three windings. Primary center-tapped for short waves. Single hole panel mount. (Model 5HT)..... **\$3.00**

**ENORMOUS VOLTAGE GAIN!
MORE VOLUME! MORE DX!
THE SHORT AND LONG WAVES
WITHOUT CHANGING COILS!**

WORKING out of a screen grid tube, the High Impedance Tuner develops incredible voltage.

The primary, the outside winding, is tuned by a variable condenser the user puts across it. At resonance this gives *infinite impedance!* What the screen grid tube needs is a high impedance plate load, otherwise the tube's full, amazing quantity of amplification is missed. Could there be any impedance higher than *infinite?*

The secondary has a step-up ratio of about 2-to-1, the first time a voltage increase by radio frequency coupling ever has been made available with a tuned primary. The secondary is wound on a separate form and riveted inside the primary form.

The third winding is rotatable inside the secondary form, from a front panel knob, and has a variety of uses. Bakelite forms are used exclusively.

It is inconceivable the revolutionary effect this coil has—volume so great you would never imagine it possible—greatly increased sensitivity, often 100 times greater than an ordinary TRF coil—more distant reception, much more, in fact—and—short waves may be tuned in by shorting out half of the primary, without change of coil or condenser.

Mount coil upside down for short leads. All terminals are then on bottom.

High Impedance Screen Grid Tuner Primary Center-tapped for short waves. Single hole panel mount (for .0005 mfd.). Model 5HT **\$3.00**
For .00035 mfd. Model 3HT..... **\$3.25**

Wonders of Screen Grid Tubes Fully Capitalized for First Time

ANTENNA COIL

Like the High Impedance Tuner, the Screen Grid Antenna Coil is specially designed for input to a screen grid tube. Its inductance is so arranged that the dial readings of the antenna circuit will be like those of the tuned circuit in which the High Impedance Tuner is used.

The antenna coupling is conductive, giving the maximum signal strength consistent with selectivity—a degree of volume that is so enormous as to astound you! Using these two coils, the volume is so great that only one stage of audio works a loud speaker superbly—thrillingly!

For short wave reception all except 14 turns of this single, continuously-wound coil are shorted out, and short-wave tuning confined to the succeeding stage or stages.

The Screen Grid Antenna Coil is matched to the High Impedance Tuner, by having dissimilar turns that equalize the tuning. Dial readings track nicely because the Screen Grid Antenna Coil's individual inductance is made to atone for the effect mutual inductance has on the High Impedance Tuner's primary.

Screen Grid Antenna Coil. One tap for short waves. For .0005 mfd. (Model 2A) **\$1.75**
For .00035 mfd. use (Model 3A)..... **\$2.00**

REPLACEMENT COIL

A great many persons now possess good radio receivers and do not desire to part with them, but would like to gain the benefit of the wonderful new screen grid tubes that, with proper coils, increase volume and sensitivity enormously, and without reducing selectivity.

Moreover, they do not want to tear down existing receivers and virtually rebuild them. No need to do so. The Screen Grid Replacement Coil, for either .0005 mfd. or .00035 mfd. tuning, occupies a space only 2 1/2 x 2 1/2 inches, so can be put in almost any receiver from which the old coil has been removed.

The replacement coil has an untuned primary of high impedance—generous number of turns—while the secondary is tuned. Thus it conforms to requirements of the usual tuned radio frequency receivers. Custom Set Builders, Service Men and Home Experimenters will welcome this opportunity to redeem "the old set," make it pep up and step out—cure that loss of the old kick—capitalize the great advantages of radio's outstanding tube! In replacement work one of these coils should be used as the antenna coil.

Screen Grid Replacement Coil for .0005 mfd. Secondary center-tapped for short waves. (Model 2R5) **\$1.50**

Screen Grid Replacement Coil for .00035 mfd. Secondary center-tapped for short waves. (Model 2R3) **\$1.75**

OTHER SCREEN GRID COILS

For circuits using screen grid tubes, with single tuning control, four models of coils are manufactured with rotors that serve as trimmers, so that no midget trimming condenser is needed.

These single control coils are:

Model 2SC5. Conductively coupled antenna coil, for input to a screen grid tube, with two turns taken from the stator and wound on the rotor. Thus the variations in tuning, due to the antenna's capacity effect on the tuned circuit, are compensated for by turning the panel knob. For .0005 mfd. tuning. Usual tap for short waves. (Model 2SC5) **\$2.75**

Model 2SC3, same as above, except that inductance is for .00035 mfd. tuning. Usual tap for short waves. (Model 2SC3).. **\$3.00**

Model 2RSC5 is a replacement coil for single control sets, corresponding to 2R5, but having the trimmer coil on a rotatable form, so that any interstage coupling out of a screen grid tube may be accomplished efficiently. Usual tap for short waves.

(Model 2RSC5) **\$2.75**

Model 2RS3, same as above, except this is for .00035 mfd. tuning. Usual tap for short waves. (Model 2RSC3)..... **\$3.00**

Coils for Other Than Screen Grid Tubes

For all circuits other than screen grid circuits the STANDARD group of coils is manufactured, as distinguished from SCREEN GRID Coils. The STANDARD coils are for 201A, 240, 199, 226AC, 227AC and all other non-screen grid tubes.

All the coils, both STANDARD and SCREEN GRID, have 2 1/2 inch diameter, the smallest diameter consistent with high efficiency!

All are sturdily made and are carefully designed and constructed with the idea of having them last TEN YEARS. That includes coils with rotatable forms, for they are no less rugged than the others—another exceptional virtue.

All coils have a short-wave tap, but this need not be used, if not desired.

STANDARD COILS

3-circuit tuner, for .0005 mfd. Secondary center-tapped for short waves. (Model T5) **\$2.25**

3-circuit tuner for .00035 mfd. Secondary center-tapped for short waves. (Model T3) **\$2.50**

TRF coil. Interstage coupler and also used as antenna coil. For .0005 mfd. Secondary center-tapped for short waves. (Model RF5) **\$1.00**

TRF coil. Same as above, except it is for .00035. Secondary center-tapped for short waves. (Model RF3) **\$1.25**

[Note: This advertisement contains our complete line of coils. Inquiries invited from the trade, custom set builders, etc.]

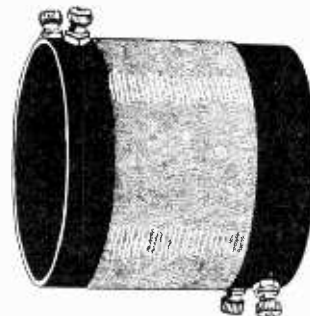

Screen Grid Antenna Coil, for input to any Screen Grid RF Amplifier. Tapped once for short waves. (Model 2A) **\$1.75**

SCREEN GRID COIL COMPANY
143 WEST 45th STREET
NEW YORK CITY
Just East of Broadway

Screen Grid Coil Co., 143 W. 45th St., N. Y. City. [Specify Quantity in the Squares]

Please mail me at once your following coils, for which I will pay post-man the advertised prices, plus a few cents extra for postage.

Model..... Model..... Model..... Model.....

Name.....
Address.....
City.....
State.....

SEND NO..... (RW)

Tried Power Amplification?

That's the only way to enjoy good programs. And it's not expensive—if you build your own. "The Gateway to Better Radio" contains just the information you need for building anything from the simplest battery-operated type to the most elaborate push-pull type for socket-power operation. Order your copy today from your dealer or direct from us. It's the wisest 25 cent investment you ever made!

CLAROSTAT MANUFACTURING COMPANY
285 N. Sixth St. Brooklyn, N. Y.

CLAROSTAT
REG. U. S. PAT. OFF.

BUILD A 36-INCH CONE—LOWEST COST FOR FINEST TONE!



NEW POWERTONE UNIT
with 10 ft. cord
Designed Front Sheet
Plain Rear Sheet
Radio Cement
Mounting Bracket
Apex Chuck
Nut
Tri-Foot Pedestal
Instruction Sheet
ALL FOR ONLY

\$6.00

Note: If 24" kit is desired, order Cat. No. 24; same price.

Cat. No. 36

REMARKABLE GUARANTY!

This 36" Cone Speaker Kit is sent complete, as listed, carefully packed. Order one sent C. O. D.

SEND NO MONEY!

Build the speaker. If not overjoyed at results, return the built-up speaker in five days and get ALL your money back!

GUARANTY RADIO GOODS CO.
145 WEST 45TH STREET
N. Y. City Just East of Broadway

COMPLETE ADVANCE STATION LIST—Sept. 22 issue of RADIO WORLD contained complete advance list of stations compiled according to the new allocation plan of the Federal Trade Commission, effective Nov. 11. Mailed for 15 cents a copy, or send \$1.00 for trial subscription of 8 weeks, including Sept. 22 issue. RADIO WORLD, 145 W. 45th Street, New York City.

PLUG AND CABLE for any SHORT WAVE ADAPTER

Handiest thing for ANY short-wave adapter. Put detector tube of your present set in

socket of any short-wave adapter you build, put plug in detector socket of your

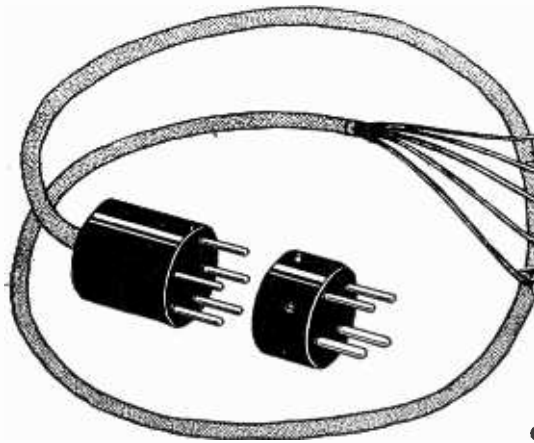

PURPLE A+C
BROWN A-O
BLACK C-O
GREEN P-O
YELLOW G-O

broadcast receiver. Cable, 34". Leads identified both by color scheme and tags. 5-prong plug and 5-lead cable for AC short wave adapter. May be used as 5-lead battery cable plug with UY socket. (Cat. No. 21AC) \$1.50 4-prong extra plug only, necessary addition to other for DC short-wave adapter (Cat. No. 21DC) \$0.50. Cat. No. 21AC and 21DC ordered together \$1.75. Cat. No. 21AC and 21DC with 99 adapter \$2.25.

GUARANTY RADIO GOODS CO.
145 WEST 45TH STREET
New York City Just East of Broadway

SUBSCRIBERS!
Look at the Expiration Date on Your Wrapper

Please look at the subscription date stamped on your last wrapper, and if that date indicates that your subscription is about to expire, please send remittance to cover your renewal.

In this way you will get your copies without interruption and keep your file complete.

SUBSCRIPTION DEPARTMENT
Radio World, 145 W. 45th St., N. Y. City

SEND FOR NEW RADIO BOOK—IT'S FREE

New hook-ups. This book shows how to make short wave receivers and short wave adapters. How to use the new screen grid tube in DC and AC circuits. How to build power amplifiers. ABC eliminators. Up-to-the-minute information on all new radio developments. It's free. Send for copy today.

KARAS ELECTRIC CO.
4039-J4 N. Rockwell Street Chicago

Name
Street and Number
City and State
4039-J3

Socket Wrench FREE!

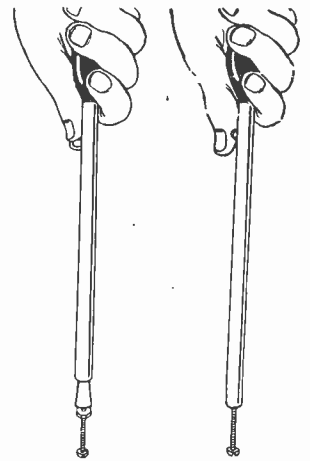

Push out the control lever with knob (as at left) and put wrench on nut. Push down on handle only (at right), then turn nut left or right.

One of the handiest tools for a custom set builder, service man or home constructor is a BERNARD socket wrench. It consists of a 6 1/4" long metal tubing in which is a plunger, controlled by a knob. The plunger has a gripping terminal (called a socket, hence the name "socket wrench") that may be expanded or contracted to fit 6/32, 8/32 and 10/32 nuts, the most popular sized nuts in radio. Use the knob to push out the plunger, press down on the handle to grip the nut, then turn the nut to left for removal or to right for fastening down. Total length, distended, including stained wooden handle, 10". Gets nicely into tight places. Send \$1 for 8 weeks' mail subscription for RADIO WORLD and get this wrench FREE. No other premium with this offer. Present subscribers may extend subs.

RADIO WORLD
145 WEST 45TH ST., N. Y. CITY
A few doors east of Broadway

Take Your Choice of 5 Other Publications

For NEW RADIO WORLD Subscribers Ordering NOW

Radio World has made arrangements

—To offer a year's subscription for any one of the following publications with one year's subscription for RADIO WORLD—
RADIO NEWS or SCIENCE and INVENTION or BOYS' LIFE or RADIO DEALER or RADIO (San Francisco).

This is the way to get two publications

- for the price of one:
- Send \$6.00 today for RADIO WORLD
- for one year (regular price
- for 52 numbers)
- and select any one of the other
- six publications for twelve months.
- Add \$1.00 a year extra for
- Canadian or Foreign Postage
- Present RADIO WORLD subscribers
- can take advantage of this offer by
- extending subscriptions one year
- if they send renewals NOW?

Radio World's Special Two-for-Price-of-One Subscription Blank

RADIO WORLD, 145 West 45th Street, New York City.
Enclosed find \$6.00 for which send me RADIO WORLD for twelve months (52 numbers), beginning and also without additional cost, Radio News, or Science and Invention, or Radio Dealer, or Radio (San Francisco), or Boys' Life (or \$10.00 for a two-year subscription to one address), thereby getting RADIO WORLD and the other selected magazine, BOTH for two years. No other premium with this offer.

Indicate if renewal. Name
Offer Good Until Street Address
November 15, 1928 City and State

NO OTHER PREMIUM OF ANY KIND WITH THIS OFFER

ELIMINATE BATTERIES!

NO Change in Set Wiring
NO Change in Tubes

"B" Eliminator, Using Raytheon Tube, Replaces "B" Batteries and Gives Great Satisfaction.

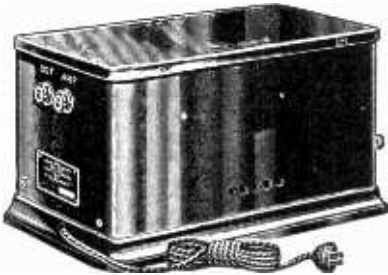

No. B16—"B" Eliminator for 50 to 60 cycle, 105 to 125-volt. AC house current. Max. voltage, 180, with one variable detector and one variable intermediate voltage. Weight 16 lbs. Size, 6 x 6 1/4 x 11 1/2". Quiet, economical. Requires no attention. Sold only with Raytheon tube. Price, including Raytheon BH125 mil. tube and built in connector cord and plug. **\$16**

Famous Raytheon Tube With Each "B" Eliminator

"A" Eliminator, Using Dry Plate Rectification, Current Well Filtered; Replaces "A" Battery.



No. A22—"A" Eliminator. Supplies up to 2 1/2 amperes at 6 volts. Variable resistance permits adjustment to number of tubes in set. Supplies A current and voltage to sets using from 4 to 10 quarter ampere tubes, or equivalent current drawn by any other combinations. TIP lacks for voltmeter readings. Receptacle for "B" eliminator plug. Pendant switch controls everything. Set switch needn't be touched. Device requires no attention. Uses no tube. Size: 10 1/2" high, 6 1/2" wide, 11 1/2" long. Shipping weight, 27 lbs. **\$22**

CUSTOM SET BUILDERS SUPPLY CO.,
57 Dey St., N. Y. City
Please ship at once—

- One 180-volt maximum "B" eliminator, with variable detector and variable intermediate voltage (three different voltages in all); equipped with one Raytheon BH tube, 125 milliamperes rating. I will pay \$16, plus a little extra for freight, on receipt of goods, which are to be on approval for ten days (money back, if desired after 10-day trial).
- One "A" eliminator, 2 1/2-ampere maximum at 6 volts, using dry plate rectification, large choke and large capacity condenser, AC switch, receptacle for any "B" eliminator plug, variable resistor, all built in for which I will pay \$22, plus a little extra for freight.
- Both the "B" eliminator and the "A" eliminator, at total of \$38, on same approval basis.

Note: If fast express shipment is preferred, rather than slower freight, put a cross here

Name.....
Address.....
City..... State.....

ALL SHIPMENTS MADE ON APPROVAL FOR TEN DAYS
All prices quoted are NET!

Learn About TELEVISION!

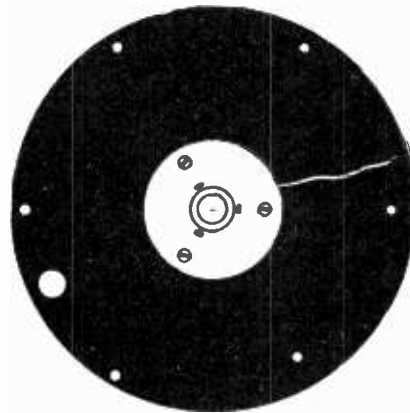

Expert articles in 16 issues give you a good understanding of this absorbing subject. Without such knowledge you may be up against it in trying to build a television receiver to tune in WGY, WLEX, WRNY, WCFL, 3XK (Jenkins) etc.

THESE ARTICLES TELL

HOW to build a scanning disc to get WGY.
to build a receiver to get television.
to connect kino-lamp (neon)
to regulate motor speed to synchronize.

And Answer 500 Other Important Questions—These Sixteen Issues Sent FREE! (See Coupon Offer)

Titles of Articles on Television and Dates of Sixteen Issues of Radio World containing those articles.

1926

Eyes to Watch Scenes by Radio, by Conrad Nugent, Dec. 25. Illustrated by photograph of Dr. Alexanderson and his first television transmitter.

1927

The Advance Toward Television Told by Alexanderson in Absorbing Brief, by E. F. W. Alexanderson, Jan. 1.
Alexanderson in Address Explains Television Theory, Jan. 22, 1927. A Simple Explanation of Alexanderson Method of Television. Also, Television Set Being Planned by General Electric, by Herman Bernard, Both in Jan. 22 issue.
Baird Uses Infra-Red in His Television Tests, by Knollys Satterwhite, Jan. 29. A brief discussion on the use of infra-red light in television experiments and possible applications.
First Television Hookups Elucidate Alexanderson and Baird Plans, by Hector Wall, Feb. 26. Hookups illustrating the principles of transmission and reception of television.
New Television Advance Demonstrated, April 23. An account of the television demonstration between New York and Washington by wire and between New York and Whippany, N. J., by radio, conducted by the American Telephone & Telegraph Company.

1928

Television Quits Dream Road for Real Bumps. Also.

The New Twist That Made Television Spurt, by Neal Fitzalan, an illustrated article comparing the Alexanderson seven-spot method of illuminating the picture to be sent, with the Gray Innovation which overcame the chief difficulty in television transmission, that of adequate illumination without imposing dangerous light intensity on the subject. Also, Television Across the Ocean Claimed by Baird Company, Feb. 4. Also, Colored Television Due; Three Coils Suggested, Feb. 4. All four in Feb. 4 issue.
Movements of Woman in London Watched from New York by Television, by Neal Fitzalan, Feb. 25. An illustrated account of successful television experiments between New York and London by the Baird system.
Television in Five Years, Not Now, Says Trade, April 28.
Jenkins Demonstrates Silhouettes in Action. Also, Nakken to Broadcast Television from WRNY. Both in May 26.
How Television is Tuned In, by Neal Fitzalan, June 9. A profusely illustrated article on the reception of television signals.
How to Connect Any Set's Output for Television Reception. An article with circuit diagrams showing how to connect the television receiving tube to the output of any radio receiver. Also, Automatic Television Synchronizing Apparatus, by Paul L. Clark. A richly illustrated article of a new system of automatically synchronizing a television receiver with the transmitter, invented by the author. Both in June 16.
The Effect of Wave and Frequency Distortion on Television Reception, by J. E. Anderson, June 23. The writer discusses the effect of wave form and frequency distortion in the transmission and reception apparatus on the received images. Illustrated with diagram showing the blurring effect of high frequency side band suppression.
Requirements for Television Reception, by J. E. Anderson, June 30. The author discusses the necessary conditions for retaining the high and the low frequencies in the side bands to prevent distortion of the received image and gives the design of a receiver which will not only give undistorted television images but which may be used as a high quality broadcast receiver.
Talking Television and How It is Worked, by J. E. Anderson, July 7. A profusely illustrated article showing how talking television works.
Mechanical Problems in Television, by J. E. Anderson, July 14. Tells how to make disc for WGY reception, also how to avoid distortion due to mechanical conditions. Also schedule of WGY television broadcasts.

RADIO WORLD, 145 W. 45th St., N. Y. City:

Enclosed please find \$6 for one year's mail subscription for RADIO WORLD, and you will please ship at once FREE the sixteen television issues as advertised and the Sept. 1st and 15th issues, 1928.

Name.....
Address.....
City..... State.....

Renewal? If you are renewing an existing mail subscription, please put cross in square after word "Renewal."

All in a Jiffy!

Tube Any Good?
Set Getting Proper Voltages?
Any Shorts or Open Circuits?
Universal Tester Answers 12 Questions in a Jiffy!

You are lost without meters when you shoot trouble and seek remedies. The Universal Tester is your reliable diagnostician for both AC and DC.

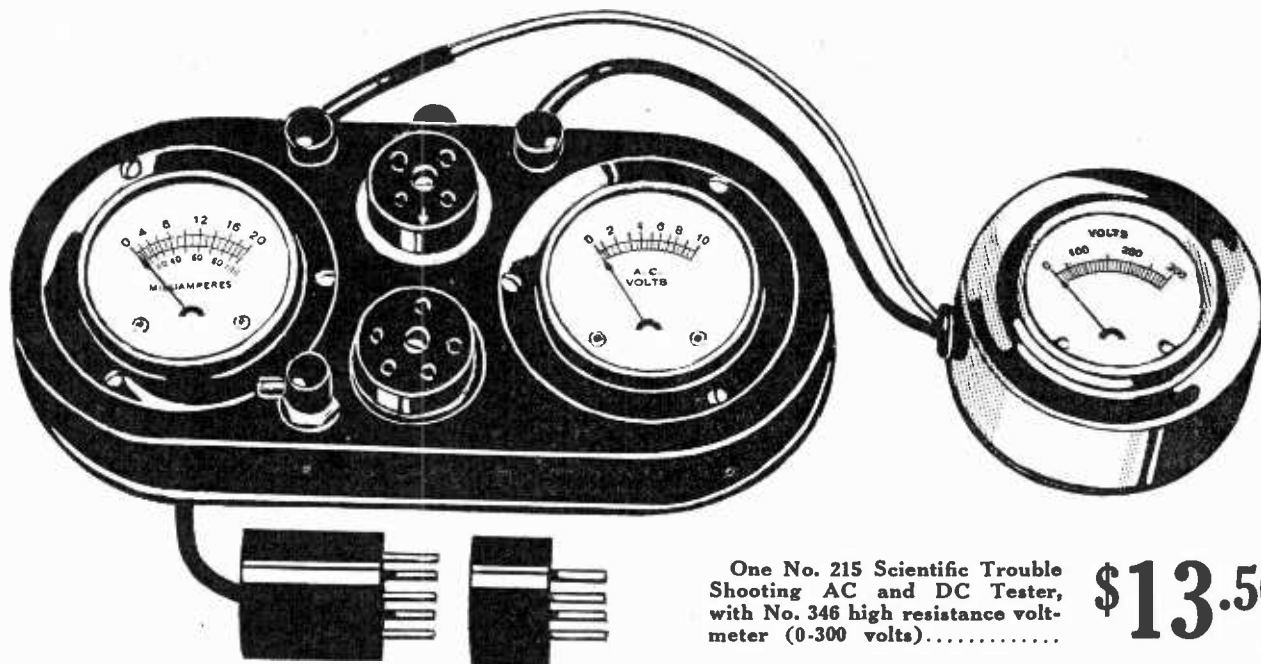

One No. 215 Scientific Trouble Shooting AC and DC Tester, with No. 346 high resistance voltmeter (0-300 volts)..... **\$13.50**

The Scientific Trouble Shooting AC and DC Tester (at left) and high resistance meter (at right) Make Twelve Vital Tests in 4½ Minutes. The instruments are exactly TWICE the size pictured. They are handy and handsome.

Amplly Accurate, Even for Service Men!

SERVICE men, going out on calls, must have a reliable test set. The Universal Tester and separate Voltmeter are reliable and versatile. The readings are accurate to 5% plus or minus, which is ample. Twice as great accuracy as this costs four to five times as much money, and isn't really necessary, except for engineering work in laboratories.

The Universal Tester and Separate Voltmeter can be used to make ALL the following twelve tests in 4½ minutes:

- (1) to measure the filament voltage, up to 10 volts, of AC and DC tubes. (2) to measure the plate current of any one tube, including any power tube, from less than 1 milliamperes up to 100 milliamperes; (3) to measure the total plate current of a receiver or amplifier, up to 100 milliamperes. (Hardly any set draws more.) Open common A and B of set and connect to P of tester socket and to P prong under adapter plug; (4) to measure the B voltage applied to the plate of tube; the voltage across B batteries or B eliminators, up to 300 volts. (5) to determine the condition of a tube, by use of the grid bias switch. (6) to measure any tube's electronic emission (tester cuts in at no load, hence plate current equals filament emission). (7) to regulate AC line, with the aid of a power rheostat, using a 27 tube as a guide, turning rheostat until filament voltage is 2.5 or 2.25 volts. (8) to test continuity of resistors, windings of chokes, transformers and circuits generally. (9) to find shorts in bypass and other condensers, as well as in inductances, resistors and circuits generally. (10) to read grid bias voltages including those obtained through drops in resistors (bias read by noting plate current and voltage and consulting chart). (11) to determine the presence of distortion and overloading, by noting if milliammeter needle fluctuates. (12) to determine starting and stopping of oscillation, as milliammeter needle reads higher current for oscillation and lower for no oscillation.

Fits Your Needs, As Well As Your Purse!

GUARANTY RADIO GOODS CO.,
145 West 45th Street, New York City.

- Please send me at once, by parcel post, on a five-day money-back guaranty, one complete Two-in-One (AC and DC) scientific trouble-shooting test set, consisting of one No. 215 and one No. 346, for which I will pay the postman \$13.50, plus a few cents extra for postage.
- If 0-500 v, high resistance voltmeter No. 347 is preferred, put cross in square and pay \$14.50, plus postage, instead of \$13.50, plus postage.
- One No. 215 and one No. 346, with two adapters for UV199 tubes \$14.50
- One No. 215 and one No. 347, with two adapters for UV199 tubes \$15.50
- One No. 215 alone, \$10.00.
- One No. 346 alone, \$4.50.
- One No. 347 alone, \$5.50.

NAME

ADDRESS

CITY STATE.....

FIVE-DAY MONEY-BACK ABSOLUTE GUARANTY!

Try out the combination tester and high resistance voltmeter, if you are a service man, custom set builder, home constructor, experimenter, teacher or student. You run no risk. These instruments are guaranteed. Money back if you're not satisfied after a five-day test.

High value and low price combine to give these instruments a field all to themselves, because they meet your needs fully in quality as well as in economy.

HERE'S WHAT YOU GET FOR ONLY \$13.50:

- (1) One two-in-one 0 to 10 voltmeter for AC and DC. Same meter reads both. Scale specially legible at 1½ to 7½ volts. This meter reads the AC and DC filament voltages.
 - (2) One DOUBLE reading DC milliammeter, 0 to 20 and 0 to 100 milliamperes, with changeover switch. This reads plate current, which is always DC in all sets.
 - (3) One 0-300 volts high resistance voltmeter, No. 346, with tipped 30" cord to measure B voltages.
 - (4) One 5-prong plug with 30-inch cord for AC detector tubes, etc., and one 4-prong adapter for other tubes.
 - (5) One grid switch to change bias.
 - (6) One 5-prong socket.
 - (7) One 4-prong socket.
 - (8) Two binding posts.
 - (9) One handsome noire metal case.
 - (10) One instruction sheet.
- [If 0-500 voltmeter No. 347 is desired instead of No. 346, price of combination is \$14.50.]
- No. 215 Universal AC-DC Tester Alone.....\$10.00
No. 346 high resistance 0-300 voltmeter alone..... \$4.50
No. 347 high resistance 0-500 voltmeter alone..... \$5.50

GUARANTY RADIO GOODS CO.

145 West 45th Street

New York City Just East of Broadway